

R.G.Abdulkarimova

**THE PROCESSES OF SELF-PROPAGATING HIGH-
TEMPERATURE SYNTHESIS**

Almaty 2019

Processes of self-propagating high-temperature synthesis

Reviewers:

Kurbatov A.P., Doctor of chemical sciences, professor of the department Chemistry and chemical technology of KazNU named after al-Farabi

Mofa N.N.,, doctor of chemical sciences, head laboratory "Mechanochemical Processes and Problems of Combustion "Institute of Combustion Problems

Annotation

The tutorial presents the physico-chemical principles, features and advantages of the SHS method over the traditional methods of obtaining materials. The theory of SHS processes is considered: chemical reactions, thermodynamics, laws and mechanisms of combustion and formation of SHS products. The specific technologies of SHS are described in detail: reactor powder, sintering, power compaction, casting and surfacing, welding, gas transmission coatings. The equipment is provided, both specialized, in which the CBC process takes place, and auxiliary one. A special place in the work is assigned to the role of scientists of the Republic of Kazakhstan in the formation and development of SHS technologies. The manual is designed for students, undergraduates and doctoral students of higher educational institutions studying in the areas “Nanomaterials and Nanotechnologies”, “Chemical Technology of Explosives and Pyrotechnic Products”, “Chemical Technology of Inorganic Substances”, “Chemistry”, as well as a wide range of specialist’s area.

TABLE OF CONTENTS	5
Introduction	
1. The processes of self-propagating high-temperature synthesis (SHS)	6
1.1. General characteristics of SHS processes	7
1.2. Chemical classes of SHS processes	
1.2.1. Gasless system	8
1.2.2. Filtration systems	8
1.2.3. Gas-discharge systems	9
1.4. Elementary basis of the theory of combustion	13
2. Regularities and mechanisms of combustion in SHS systems	23
2.1. Gas-free system	23
2.2. Solid-gas systems	37
3. Thermodynamics and kinetics of SHS-reactions	46
4. Experimental methods for studying SHS-processes	51
5 Structuration of SHS-products	61
6 Technological bases of SHS processes	70
6.1 SHS-technology of powders	71
6.2 SHS-sintering	73
6.5 Technology of gas transmission SHS	
Coating	
6.6 SHS-Metallurgy	75
7 Scientific principles of management of processes and products of SHS compaction	87
8 Formation of layered compositions on steel substrates	95
9 Mechanochemical processes in solid inorganic substances	100
10. The contribution of Kazakh scientists to the development and development of SHS technologies	105
11 PROSPECTS OF DEVELOPMENT OF SHS-TECHNOLOGIES	
11.1 Organic Self-Propagating High-Temperature Synthesis	111

INTRODUCTION

Self-propagating high-temperature synthesis (SHS) - a kind of combustion, as a result of which a short period of time formed valuable in practical terms, solids and materials. The development of the works is based on the scientific discovery of Soviet scientists A.G. Merzhanov, V.M. Shkiro and I.P. Borovinskaya "The phenomenon of wave-new localization of self-locking solid-phase reactions", made in 1967.

The essence of the SHS process lies in the spontaneous spread of a chemical reaction in environments capable of releasing chemical energy with the formation of valuable condensed products. The process is possible in systems with various aggregate states (mixtures of powders, hybrid systems, solid-gas, solid-liquid, etc.), has a thermal nature. The main purpose of SHS is the synthesis of substances and materials in the wave of combustion, the creation of new technological processes and the organization of new industries.

Recently, the integrated use of self-propagating high-temperature synthesis with preliminary mechanochemical activation (MA) of raw material for directional changes in the state and structure of constituent components is one of the most effective approaches in the development of new composite materials, including nanostructured with a set of unique properties.

In the training manual are given the physicochemical basis, features and advantages of the SHS method over the traditional methods of obtaining materials. The theory of SHS processes is considered: chemical reactions, thermodynamics, regularities and mechanisms of combustion and formation of SHS products. Specific technologies of SHS are described in detail: reactor powder, sintering, power compaction, casting and surfacing, welding, gas transmission coatings. The equipment is presented, both specialized, in which the SHS process takes place, and auxiliary.

A special place in the work is given to the role of scientists of the Republic of Kazakhstan in the formation and development of SHS-technologies.

The manual is designed for students, undergraduates and doctoral students of higher educational institutions studying in the fields - "Nano-materials and nanotechnologies", "Chemical technology of explosives and pyrotechnics", "Chemical technology of inorganic substances", "Chemistry ", As well as a wide range of specialists: researchers, engineers and industrialists in the field of powder metallurgy, technical ceramics, refractories, composite materials.

1. The processes of self-propagating high-temperature synthesis (SHS)

1.1. General characteristics of SHS processes

Among the various trends in chemical physics, the study of burning processes occupies a special place. The possibility of rapid achievement of the high-temperature state of matter, accompanied by a variety of physicochemical, phase and structural transformations in the combustion wave, combined with high informativeness of the measured process characteristics, made combustion not only an object, but also one of the promising methods of physic-chemical research. A vivid example of this position is the study of the process of self-propagating high-temperature synthesis (SHS).

SHS, in its essence, is one of the varieties of combustion processes, and, consequently, has a thermal nature. The phenomenon of SHS was first discovered in 1967 by A.G. Merzhanov, I.P. Borovinskaya and V.M. Shkiro (Academgorodok Chernogolovka, Moscow region) in the study of gas-free burning of mixtures of powders of metals and nonmetals. As metals, they acted as metals (Ti, Zr, Hf, Nb, Ta, etc.), and as an oxidizer-nonmetals (B, C, Si). With the help of local initiation, wave (self-propagating) regimes were realized in which the chemical transformation is concentrated in a zone moving along a mixture of powders. A characteristic feature of the first studies is that during the process there is practically no gas evolution and completely condensed products are formed, and very high temperatures (up to 4000°C) can develop in the condensed phase. The possibility of such gas-free combustion is caused by a large heat-division during the chemical interaction of the reactants and the thermal stability of the products.

A combustion wave propagates through the mixture, the unusual nature of this burning was the absence of flame, that is, gaseous combustion products. Initial reagents, pro-intermediate and final products of re-action are in a condensed (solid or liquid) state. But this fact did not cause a special interest of the researchers, as before, metal-thermal processes and other types of combustion with low gas evolution were known. The advantage was that the products of combustion represented high-quality refractory compounds. It is known that in order to synthesize these compounds by traditional furnace methods, one needs hours of electricity, and the combustion wave copes with this task in seconds. At the same time, neither complex equipment nor large energy inputs are required. In addition, the purity of the product is limited only by the number of initial reagents. In many cases, the product contains fewer impurities than the original mixture, since the volatile impurities "burn out" in the SHS wave, SHS processes are characterized by

a high temperature (1,500-4000°C) and a high propagation velocity of the front burning (0.5-15 cm/s). High combustion rates provide high process efficiency. Naturally, these advantages make it very promising to use SHS processes for the synthesis of many refractory compounds and materials, such as ceramics, cermets, hard alloys, coatings and others.

The SHS method is based on the reaction of the exothermic interaction of two or several chemical elements, compounds, proceeding in the directional combustion mode. Following the classical combustion model, after local initiation of the reaction, the reactant interaction process is carried out in a thin layer and propagates throughout the system due to the heat transfer from the hot products in the reaction zone to the cold layers of the starting material.

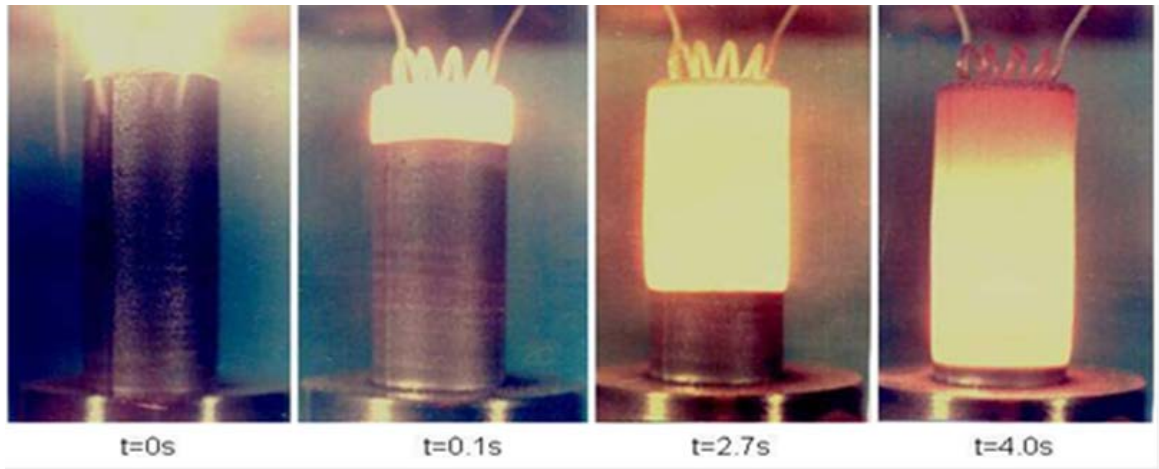

Fig1 -Stages of the process of self-propagating high-temperature synthesis

The propagation velocity of the reacting layer and the reaction temperature depend on a number of physicochemical parameters. These include:

- thermodynamic parameters (heat of formation of final products of synthesis, heat capacity of reaction products, initial temperature of the process, composition of the initial mixture);

- physical parameters (thermal conductivity of the initial mixture, shape and particle size of the powders, sample density, external gas pressure, polydispersity of the powders, defect structure of the component particles, presence of external influences);

- technological parameters (uniformity of mixing of the initial components of the mixture, degree of activation of powders);

- chemical parameters (degree of moisture of powders, concentration of adsorbed impurities and dissolved gases in them).

1.2. Chemical classes of SHS processes

The SHS process diagram can be represented in the following form:

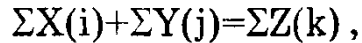

where X (i) is a metal in the solid state, for example, Mg, Al, Ti, Zr, Hf, V, Ta, Nb, Cr, Mo, Ni, etc ; Y (j) is a non-metal or metal in a solid, liquid or gaseous state, for example. C, B, Si, S, Se, N₂, O₂, H₂; Z (k) - synthesis products: carbides, borides, silicides, sulphides, selenides, nitrides, oxides, hydrides, solid solutions, intermetallics (if Y (j) is metal), respectively. Depending on the chemical nature of the leading combustion reaction and the aggregate state of the components, all SHS systems can be divided into four main classes: gas-free, filtration, gas-evolving systems and systems of metallothermic type (with a regenerative stage).

1.2.1. Gas-free systems

In such systems, the initial components, intermediate and final products are in a condensed (solid or molten) state. In this case, the emission of gases is practically absent (a small gas evolution is usually associated with self-cleaning from impurities at high temperatures). The composition of the products and the combustion parameters depend little on the external environment, so the synthesis process can be carried out in a vacuum or in an inert gas environment at different pressures. The main factors controlling synthesis are: the composition of the mixture of the initial powders, the co-ratio and the size of the particles of the reagents, the density of the mixture, the diameter of the sample, etc. According to the scheme of gasless syntheses, borides, carbides, silicides, intermetallics, consisting of thermally stable elements at high temperatures. Based on the SHS method, the problems of synthesis of solid solutions, nonstoichiometric carbides, borides, carboborides, hard alloys, porous products are solved.

1.2.2. Filtration systems

Filtration syntheses are carried out in hybrid metal-gas systems. Their main feature is a strong dependence of the composition of products and combustion parameters on the pressure and composition of the gaseous medium, on the diameter of the briquette and its permeability.

Of great importance is the method of delivering the gas reagent to the combustion zone: spontaneous filtration (the combustion zone fulfills the role of the "pump" sucking the gas reagent), purging (super-diabatic regime including).

A feature of filtration syntheses is that a decrease in temperature and burning rate leads to an increase in both the amount of bound gas in the product and the uniformity of its distribution over the volume of the sample. This feature is caused by the possible melting of the reaction products, deterioration of the permeability of the sample and the absence of afterburning processes. The possible way to avoid these undesirable processes and improve the quality of the products is dilution of the charge or reacting gas with inert products and gases.

The quality of the synthesized products of filtration processes depends on the ratio of the characteristic filtration times (t_f), chemical reaction (t_R) and thermal relaxation of the product (t_0).

In the case of short filtration times $t_f \ll t_R \ll t_0$, before the main reaction occurs in the heating zone, the gas has time to diffuse to the entire depth of the porous sample. In this case, the afterburning processes can be completed before the products are completely cooled.

The condition $t_f \ll t_R$ corresponds to the so-called stratified burning regime. With the ratio $t_f \gg t_R$, combustion proceeds in the surface mode, when the central part of the sample remains unburnt.

In the works of I.P. Borovinskaya and co-authors introduced the criterion of filtering combustion K_1 , equal to the ratio of the characteristic filtration times and chemical reactions in the form:

$$K_1 = t_f / t_R = 4vRT_0 / (\pi^2 \mu) \times U_m d / k P_0^2,$$

where R is the gas constant; μ is the molecular weight ($\text{g}\cdot\text{mol}^{-1}$); v is the power exponent in the law $U_m \approx P^v$; U_m is the gas absorption rate in the sample ($\text{r}\cdot\text{cm}^{-1}\cdot\text{sm}^{-1}$); P_0 is the gas pressure (atm); d is the diameter of the sample (cm); T_0 is the temperature of the cold end (K); k is the permeability coefficient ($\text{cm}\cdot\text{c}^{-1}\cdot\text{atm}^{-1}$).

Important for filtration syntheses is the afterburning process. Since a 30-50% conversion is sufficient for the spontaneous propagation of the combustion wave, subsequent reaction is possible only if there is a burn-out stage. In view of the high temperatures developed in the combustion zone, the condition $T_c > T_m$ can be realized (T_m is the melting point of the products of synthesis, T_c is the burning temperature) at which the intermediate products melt, and the permeability of the sample is substantially reduced. The gaseous reagent, by the mechanism of

reaction diffusion, saturates only the surface layers of the sample, and the internal part remains unreacted.

In the practice of filtration syntheses, a number of final combustion products are often added to the initial components (for example, in the synthesis of titanium nitride by the reaction $2\text{Ti} + \text{N}_2 \rightarrow 2\text{TiN}$, titanium is added to the titanium), which avoids the melting of synthetics and retains sufficient afterburning permeability.

It should be noted that the filtering factors important in the synthesis of nitrides play a less significant role in hydride synthesis processes because of the high diffusion mobility of hydrogen, and the homogeneity condition is almost always satisfied.

1.2.3. Gas-discharge systems

This class includes systems with easily volatile components - sulfur, phosphorus, selenium, tellurium, and also with liquefied gases (liquid nitrogen). The main difficulty in carrying out such syntheses is associated with the loss of reagent to the environment. The simplest solution is to use hermetic vessels completely filled with burden. In this case, the evaporating reagent does not leave the reaction volume, but fills only the porous space. The loss of the reagent can be controlled by the pressure of the external gas. Thus, qualitative sulphides, selenides, tellurides, phosphides and other chalcogenides are obtained.

1.2.4. Systems with a reducing stage

Combustion in such systems has two fundamentally different chemical stages: the restoration of elements from oxides, the interaction of elements with each other and with additives. The most well known are the magnesium-thermal and aluminothermic SHS processes.

The chemical scheme of magnesium-thermal SHS processes in general form can be summarized as follows:



where X, Y - the chemical elements that make up the refractory compound; μ , ν , m , n - stoichiometric coefficients. An example is the reaction:

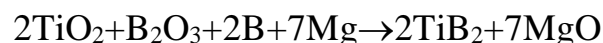

The combustion product is two-phase, and magnesium oxide is evenly distributed in the combustion product. Therefore, to separate the target product

from magnesium oxide, an additional technological stage of chemical washing is introduced, if the aim of the synthesis is to obtain titanium diboride.

The chemical scheme of aluminothermic SHS processes is analogous to the above, with the only difference being that Al is used instead of Mg. The peculiarity is that in most systems the combustion temperature is much higher than the melting temperature of the reaction products. In connection with this combustion product is a multicomponent high-temperature melt. In the melt under the influence of gravity, phase separation takes place - light alumina emerges, and a heavy refractory compound drowns. Therefore, in contrast to magnesium thermal processes, the problem of isolating the target product is solved. On the contrary, in a number of cases there are problems of obtaining cast ceramics like $Al_2O_3-Me_xC_y$, $Al_2O_3-Me_xB_y$. In this case, the phase separation process slows down or decreases the characteristic time of thermal relaxation, accelerating the crystallization of the decomposition of chemical reaction products until the phase separation is complete.

In the majority of SHS processes, the reducing (termite) stage is supplemented by the stage of formation of refractory compounds of the restored elements (the phase of the SHS proper):

SHS carbides:

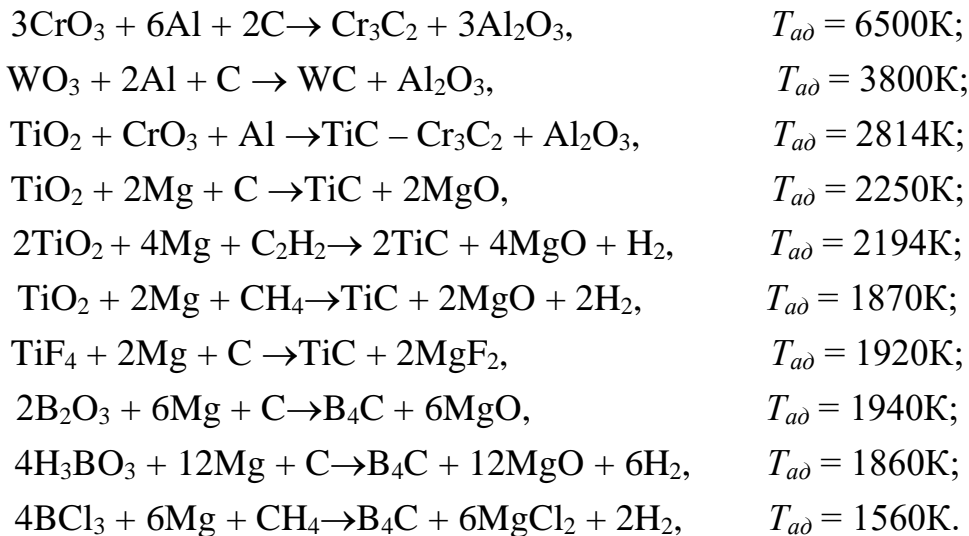

SHS borides:

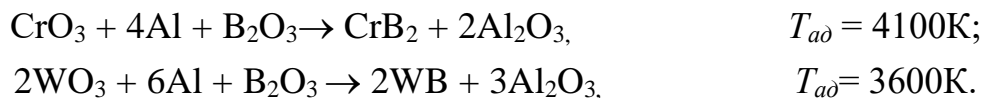

SHS silicides:



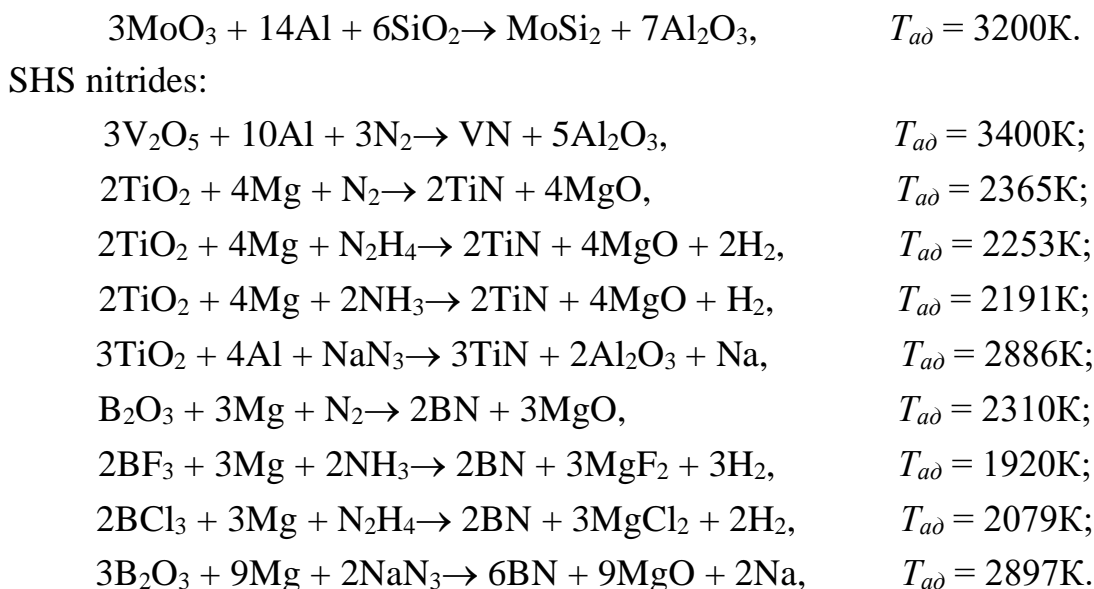

1.3. Classes of SHS products

As noted above, the SHS method was first used to synthesize refractory inorganic compounds. Over the next few years, the range of SHS products has expanded so much that hardly anyone today can name the exact number of compounds, materials, products that were produced by the SHS method in laboratory or industrial conditions. It is clear only that the bill here goes to hundreds. Therefore, in modern, highly expanded interpretation, SHS is a combustion process of any chemical nature, leading to the formation of valuable in practical terms condensed products (materials). The environment, capable of reacting in the SHS mode can be very different: solid, liquid, gaseous, mixed. It is important only that the cooled combustion product is a solid and provokes interest for further use

Among the variety of processes and products of SHS, the following main classes can be distinguished.

Carbides:

TiC_x , ZrC_x , HfC , VC , NbC , Nb_2C , TaC , SiC , WC , Cr_3C_2 , Cr_7C_3 , Mo_2C , others.

Borides: TiB_2 , TiB , ZrB_2 , ZrB_{12} , HfB_2 , VB_2 , VB , NbB , NbB_2 , TaB , TaB_2 , CrB_2 , CrB , MoB , MoB_2 , WB_2 , others.

Nitrides: BN, TiN, ZrN, HfN, VN, NbN, TaN (ky6), TaN (hexagonal), Ta₂N, others.

Silicides: TiSi, TiSi₂, ZrSi₂, ZrSi, WSi, others

Chalcogenides: TiSe₂, NbSe₂, TaSe₂, MoSe₂, WS₂, WSe₂, others.

Solid solutions: TiC-Cr₃C₂, TiC-WC, TiC-TiN, NbC-NbN, MoS₂-NbS₂, TaC-TaN,

Nb_xZr_{1-x}C_yN_{1-y}, others.

Intermetallides: Ni₃Al, NiAl, TiAl, TiNi, Cu₃Al, TiCo, CoAl, Nb₃Al, others

Oxides: aluminates (YAlO₃, MgAl₂O₄), niobates (LiNbO₃, NaNbO₃, BaNb₂O₆), garnets (Y₃Al₅O₁₂, Y₃Fe₅O₁₂), ferrites (CoFe₂O₄, BaFe₂O₄, Li₂Fe₂O₄), titanates (BaTiO₃, PbTiO₃, etc.), molybdates (BiMoO₆, PbMoO₄, etc.), superconducting oxide ceramics (YBa₂Cu₃O_{7-x}, LaBa₂Cu₃O_{7-x}, etc)

Ceramics in systems based on:

BN, TiC-TiB₂, TiB₂-Al₂O₃, AlN-BN, AlN-TiB₂, Si₃N₄-TiN-SiC, SiAlO_xN_y, others.

Cermets: TiC-Ni-Mo, TiC-Cr₃C₂-Ni, TiC-TiN-NiAl-Mo₂C-Cr, TiB-Ti, others.

The list of SHS products is constantly updated not only due to new chemical compounds, but also due to the synthesis of materials with an uncommon structure. For example, recently there have been reports on the synthesis of highly porous foam-like materials under conditions of weightlessness, on the radiation of nanocrystalline powders, and others.

1.4. Elementary basis of the theory of combustion

The theory and practice of combustion, especially of condensed systems, such as explosive substances, propellants, rocket fuels, had the greatest influence on the formation of SHS. From this field of knowledge, the methods of experimental study of the propagation of the combustion front in a "constant pressure bomb" with photographic registration of the process, thermoelectric and optical methods for measuring the combustion temperature, calorimetry and thermodynamic analysis of burning processes, basic equations for describing combustion waves, etc. were borrowed from this area of knowledge. The theory of grief and the chemistry of refractory compounds have ensured the sustainable development of research in the field of SHS. At the same time, it should be noted that SHS has its own scientific apparatus. It differs from conventional combustion processes in that it takes into account the important stage of structure formation in products, and

from the synthetic chemistry of materials - autowave character and small characteristic synthesis times. The development of SHS led to the creation in the theory of combustion of a new large section, which was called "hard flame combustion."

Let us consider the problem that confronts every chemist and material scientist beginning research in the field of SHS. This problem is the apparent "unmanageability" of SHS. Indeed, after the initiation, the combustion wave spreads spontaneously. The speed of its propagation, temperature, concentration at each point of the SHS wave is determined by the internal parameters of the system, the reserve of chemical energy, the kinetics of the reaction, the thermal conductivity, and so on. Is it possible to control the synthesis process under these conditions? Is it possible to obtain the desired composition, structure and properties of the SHS product? And is high stability of results achievable? It seems to us that the entire 30-year history of the development of SHS is the search for answers to these questions. In some specific cases, answers have been found, but in others, studies continue. The success of these studies depends on an understanding of the mechanisms of the processes occurring in the SHS wave. In order to understand the nature of SHS, it is necessary to familiarize yourself, at least with the elementary foundations of the theory of combustion.

Propagation of the combustion wave is one of the possible regimes in which exothermic chemical reactions can occur. When the combustion wave propagates, the initial mixture of reagents is separated by a relatively narrow combustion zone from the reaction products, as shown in Fig. 2a. The initial temperature of the substance T_0 is comparatively low (for example, room temperature), and the temperature of the products, called the combustion temperature, reaches thousands of degrees Kelvin. In steady-state conditions, the combustion zone moves toward the source mixture at a constant velocity U , called the normal burning rate. Since this speed is constant, we can combine the coordinate system with the combustion zone. Then this zone will be unmovable, and the substance will flow into the combustion zone at a speed U and flow out of it with the same velocity (we neglect the change in the volume of matter due to the reaction). The temperature profiles in this wave look as shown in Fig. 2b. We consider the one-dimensional case under the assumption that the rate of heat release depends only on the temperature. Then the process of propagation of the steady-state combustion wave is described by the heat conduction equation.

$$\frac{d}{dx} \left(\lambda \frac{dT}{dx} \right) - c\rho U \frac{dT}{dx} + Q\Phi(T) = 0 \quad (1)$$

with boundary conditions
 $x \rightarrow -\infty: T = T_0; x \rightarrow +\infty: T = T_c; (2)$

Here T is the current temperature, x is the spatial coordinate, T_0 is the temperature of the initial mixture, T_c is the temperature of the products of combustion, Q is the heat of the chemical reaction, and $\Phi(T)$ is the function describing the rate of chemical transformation as a function of temperature.

Physical parameters λ (thermal conductivity), C (heat capacity) and ρ (density), as well as Q (heat of reaction) and $\Phi(T)$ (reaction rate) are properties of the reaction mixture. In addition to these, the equation contains an unknown linear burning rate U , which must be determined from the solution of the problem. The existence of a unique value of U for these physical parameters will mean that at each point of the medium the velocity of the combustion wave, and, consequently, its structure (as will be seen from what follows) remain constant. With regard to the SHS wave - this is a guarantee of stability of the synthesis conditions throughout the volume of the reaction mix. A single-valued dependence of U on physical parameters will also allow us to control the SHS process, since we can vary these parameters over a relatively wide range. That is why it is so important to determine the burning rate from the solution of this problem.

Meanwhile, at first glance, it may seem that (1) has a solution for any values of U , since this equation is of the second order. Accordingly, there are two boundary conditions for the determination of two arbitrary integration constants. But this is not so. The point is that the boundary conditions are given for $x = \pm \infty$. Therefore, the solution is invariant under the coordinate shift, that is, if some function $T_0(x)$ is a solution of (1), then the solution is also the function $T_0(x + C_1)$, where C_1 is an arbitrary constant. Thus, one of the integration constants can not be determined in principle, and in this sense one of the boundary conditions is "superfluous". Because of this overdetermination of the problem, the solution (1) satisfies the boundary conditions only for some definite value of U . Thus, as a result of shear invariance, the parameter U appears as the eigensolution of problem (1). In connection with this, questions arise: 1) whether there is a solution of such a problem to its own values and 2) whether this solution is unique. The combustion theory gives positive answers to these questions, provided that, firstly, $\Phi(T_0) = 0$ and, secondly, the leading combustion wave is one chemical reaction. Strictly speaking, the condition $\Phi(T_0) = 0$ can not be fulfilled (although it is just a consequence of the boundary condition $x \rightarrow -\infty: T = T_0$) for values of T_0

that are different from absolute zero. From chemistry it is known that reactions occur at any, even very low temperatures, but the reaction rate is very small. Therefore, there is a significant temperature range in which the response can be avoided. For example, most SHS mixtures can be stored at room temperature for almost unlimited time without any trace of reaction.

Thus, the combustion theory guarantees us that if we take a stable combustible mixture at room temperature in which there is no competing reaction, then irrespective of the ignition method, a stationary combustion wave will be established in this mixture. The structure of the combustion wave and the speed of its propagation will be constant in time and depend only on the physical parameters of the mixture.

The basic formula for the burning rate is in the approximation of a narrow reaction zone, which is often called the Zeldovich formula, after the name of the outstanding Russian physicist, who first received it for gas flames (Zeldovich, 1938):

$$U = \frac{1}{c\rho(T - T_0)} \sqrt{2Q \int_{T_0}^{T_c} \lambda \Phi(T) dT}. \quad (3)$$

This formula, applied to a flame for the first time, VA. Mikhelson, describes the stationary temperature profile of the heating zone. The quantity $l \sim \alpha/U$, having the dimension of length, is called the thickness of the heated layer, and the time interval $\tau = l/U = \alpha/U^2$ characterizes the heating time of the mixture in the pre-flame zone.

Let us now proceed from the coordinate system associated with the wave of grief, again to the coordinate system tied to a point of the reagent medium (Figure 26). This point "does not know" that a wave of combustion spreads through the medium, about the shape of this wave. Suppose that at the initial instant of time ($t=0$) the selected point was at a distance x_0 from the reaction zone of the combustion wave. Then it is obvious that with time the temperature at this point will vary according to the law:

$$T = T_0 + (T_c - T_0) \exp\left(\frac{U(Ut - x_0)}{\alpha}\right) \quad \left. \begin{array}{l} t < x_0/U \\ T = T_c \end{array} \right\} \quad (4)$$

This dependence, shown in Fig. 2b, is, in fact, the temperature regime of high-temperature synthesis in the wave of burning. What are the main differences between this heating method and traditional heating methods? Let us single out three of them.

Firstly, these are extremely high heating rates, reaching 10^5 - 10^6 K/c. In other ways, it is practically impossible to achieve such speeds for heating massive objects.

Secondly, the combustion temperature of the T_C reaches high values, up to 3000-4000 K. Obtaining such temperatures in furnaces requires complex equipment and large energy inputs, so it often turns out to be economically inexpedient.

Thirdly, heating occurs identically at each point (in contrast to external heating) due to the heat of reaction, but at the same time, various spatial regions of the preform (medium) do not heal at the same time.

All these features point to the need to look for non-traditional ways of controlling the synthesis process. In this case, we can influence both the heating region (combustion front) and the duration of isothermal aging and the cooling rate. We first consider the singularities of the temperature profiles of the combustion wave, characteristic of SHS systems. The point is that the above structure of the combustion wave is strictly realized only in premixed gas flames. An analysis of the applicability of this approach to heterogeneous media (in particular to SHS mixtures) was carried out by B.I. Khaikin and A.G. Merzhanov. It was shown that the theory of thermal waves in homogeneous schemes can be applied to heterogeneous mixtures in those cases when the thermal diffusivity of the medium is much greater than the diffusion coefficients of the reagents. This condition means that the temperature of the neighboring reagent particles is leveled much faster than the reaction between them. Then we can approximately consider the heterogeneous mixture as a homogeneous medium in the heat medium. Where do the "features" associated with the heterogeneity of the mixture "hide"? Within the framework of this model, all these singularities are expressed in terms of the form of the heat release function $F(T, \eta)$.

In general, this function can be written as

$$F(T, \eta) = Q\varphi(\eta) \exp\left(-\frac{E}{RT}\right) + L\psi(T, \eta). \quad (5)$$

Note that here we take into account the dependence of the reaction rate not only on temperature (the Arrhenius law) but also on the depth of the transformation (function $\varphi(\eta)$). The conversion depth is defined as $\eta=(C_0-C)/C_0$, where C_0 is the initial concentration of the reagent, C is its current concentration during the reaction. In addition, expression (12) takes into account the possibility of separating or absorbing heat in the result of the phase transition (melting, crystallization, etc.): here L is the heat of the phase transition, and the function $\psi(T,\eta)$ describes the kinetics of the transition. I with a source nick-form (12), including computer modeling, and-set are compared with the experimental results of the combustion wave structure allowed Merzhanov AG et al suggest, generalized formula for the velocity of propagation of the combustion front:

$$U^2 = A(T^*, \eta^*) \exp\left(-\frac{E}{RT^*}\right)$$

where T^* and η^* are some intermediate values of the temperature and depth of the transformation, which are determined from the additional conjugations in each specific case, and $A(T^*, \eta^*)$ is a weak power function.

Here are some examples of the determination of T^* , η^* and the corresponding combustion wave structures:

- a) For the combustion with narrow zones already discussed above (the Zel'dovich-Frank-Kamenetski model)

$$\eta_* = 1; T_* = T_c \approx T_0 + Q/C,$$

that is, the burning rate is determined by the final temperature of the mountain. The structure of the combustion wave with narrow bands is shown in Fig. 3a.

- b) Consider burning with wide zones. The concept of wide zones of re-action was proposed in 1972. Khaikin, A.G. Merzhanov, A.P. Al-Sutra on the basis of an analysis of the features of gas-free burning of mixtures of metal powder and nonmetals. The strong inhibition of the reaction of the interaction of the components, the polydispersity of mixtures and other features lead to a strong broadening of the reaction zone. In this case

$$T_* \approx T_0 + (Q/C)\eta_*.$$

$$(Q/C)F_T'(T_*, \eta_*) + F_\eta'(T_*, \eta_*) = 0.$$

The structure of the wave is shown in Fig. 36. The width of the reaction zone is greater than that of the heating zone. The maximum rate of heat release is at temperatures significantly lower than T_C , and the degrees of conversion that are substantially less than unity. As a result, the reaction zone is divided into two subzones. In one there is a rapid heat release, in the other - a slow one. The parameters at the boundaries of these zones T^* and n^* determine the burning rate.

c) Another example of the complex structure of the combustion wave, characteristic of many SHS systems, is combustion with a phase transition. We stop on phase transitions of the first kind, such as melting. If the melting proceeds simultaneously with the chemical reaction (which is very characteristic for SHS mixtures), a plateau (isothermal pad) with a temperature of the phase transition $T^*=T_{III}$ can form on the temperature profile. (Figure 3B). The presence of the site produces a thermal balance - the chimic heat release is completely absorbed by the phase transformation. In this case, T^* and n^* are easily defined:

$$\eta_*' = 1; T_* = T_C \approx T_0 + Q_i / C,$$

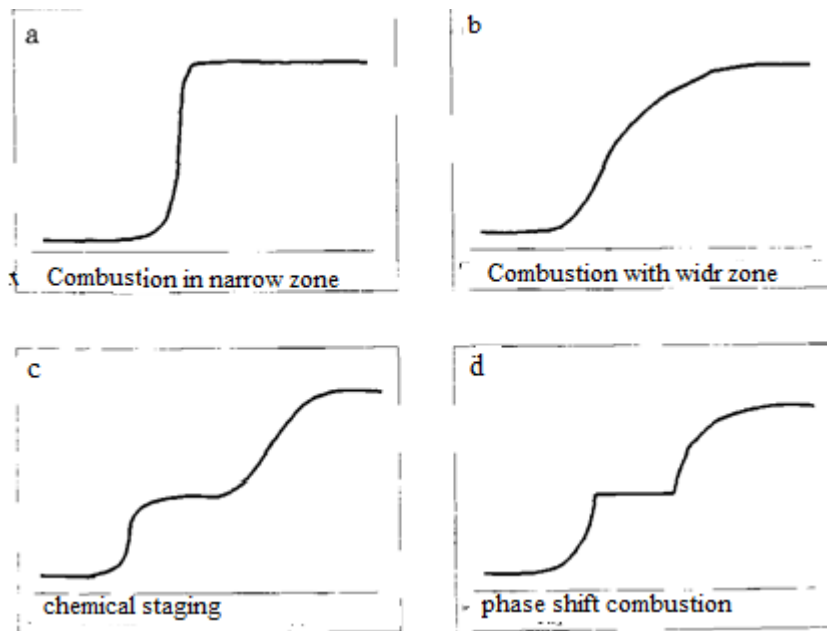

Fig. 2. Types of temperature profiles in SHS

d) Very often the nature of the temperature profile of the combustion wave is affected by the chemical staging of the interaction of reagents. Complete chemical

transformation occurs in several stages, each of which corresponds to the heat of reactions Q_i and its intermediate product. These stages can be spatially separated in a combustion wave (the so-called "detachment" mode). The structure of the combustion wave in this case has the form shown in Fig. 3 for a two-stage reaction. In this mode

$$\eta_*' = 1; T_* = T_C \approx T_0 + Q_i / C,$$

where Q_i is the thermal effect of the low-temperature stage, η_*' is the depth of conversion at the first stage.

All the types of combustion wave structures considered can be realized in SHS experiments. In some systems, very complicated temperature profiles are observed that have inflections, isothermal areas and other features (measured with the aid of microthermocouples) associated with various phase transitions, formation of intermediate products, etc., as can be seen, for example, in Fig. 3.

Summarizing the contents of this section, we come to the conclusion that heating of reagents in the SHS wave can occur both in a simple and very complicated manner. The heating rate can vary at any instant of time in a very wide range from 0 to 10^6 K/c, which is not available to other methods. Adjustment (control) of the heating profile is possible by setting the initial temperature, the porosity of the medium, dilution with the final or intermediate products, the dispersion of the reagents and the use of reagents of different nature. For example, we can introduce carbon into the reaction mixture in the form of different grades of soot, graphite or hydrocarbons. In each case, we will receive our own temperature profile. An equally important role in the synthesis is played by the cooling rate of the product, which can be relatively easily regulated by changing the conditions of the heat sink.

Thus, synthesis in a combustion wave is not a fire, it is not the chaotic combustion of something with something. It is a controlled process strictly obeying its own internal laws. The study of these laws and the development of methods for managing product synthesis is one of the main issues of the science of SHS.

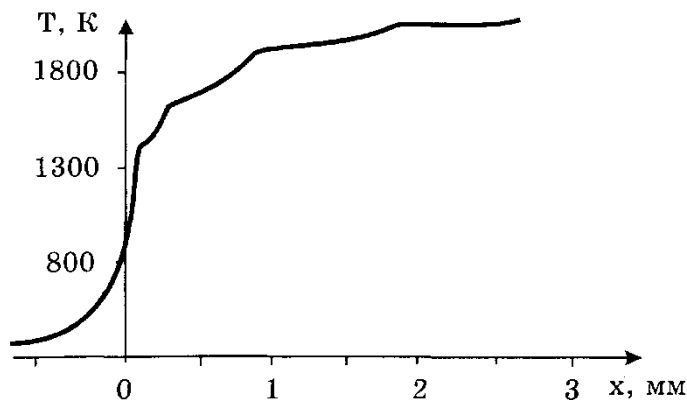

Fig. 3. An example of a temperature profile in the Ti + 3Si system

Studies of the structure of the combustion wave, combining temperature measurements with the determination of profiles of concentrations of reagents and products, allow one to reliably understand the complex picture of substance transformations and understand the mechanism of SHS processes.

Such studies have shown that in SHS processes the structure of the combustion wave is more complex than the classical structure of the combustion wave described above, consisting of only two zones: heating and reaction, separated by a combustion front with a temperature $T_{\phi p}$. (temperature of the combustion front $T_{\phi p}$). Several zones are formed behind the combustion front in the SHS systems (Figure 4) The zone of chemical transformation III with the main heat release is directly adjacent to the combustion front, it is this zone of the main combustion reactions that determines The combustion zone is followed by the upstream zone III, and with chemical side reactions, the depth of the chemical transformation in which can be significant. The important feature of SHS processes is the presence of a broad zone of IV phase and structural transformations in the primary products of go rhenium, when the chemical processes have been completed, Zone IV determines the structure of the final products and plays an important role in the formation of the properties of the material synthesized. In the zone of cooling of the products V, the rate of cooling can influence the ordering of the structure of the formed product. The auto-annealing takes place and the product has an equilibrium structure. With rapid cooling, hardening takes place, and the product remains with a no equilibrium structure.

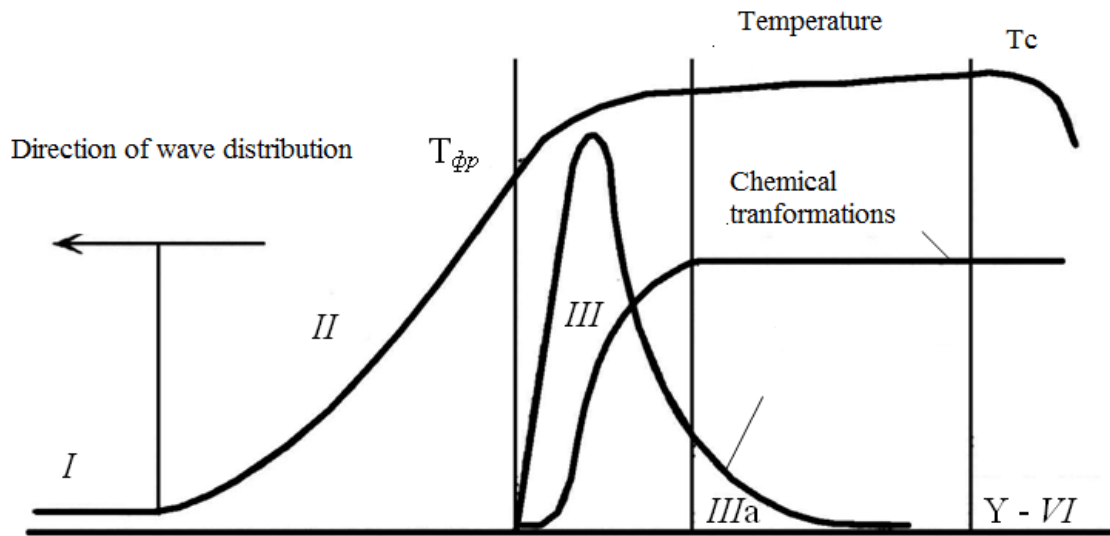

Fig. 4 Wave complex in the SHS system

along a spatial coordinate along a stationary combustion wave:

I - initial reagents, II - combustion wave, III - the main zone of heat release, IIIa - zone of afterburning, IV - formation of phases and structures in primary products, V - cooling of products, VI - final SHS products

Thus, the propagation speed of SHS processes is determined by the release and propagation of heat in the main combustion zones II and III, and the characteristics of the final products depend on the subsequent zones III, a - V, in which post-processes of afterburning, phase and structure-formation, cooling.

2. Regularities and combustion mechanisms in SHS systems

2.1. Gas-free systems

In this lecture we will consider the first of the classes of SHS processes - gas-free combustion, or rather, one of its varieties - synthesis from the elements in the gas-free regime. The chemical nature of this process is expressed by the following scheme:



that is, in a mixture of solid products in the initial state, a chemical reaction takes place in the form of a combustion wave with heat release Q . It is understood that an increase in temperature in a wave can lead to the melting of one or both reagents, the reaction product can also be formed partially or completely in the form of a melt. The principal for this model is, first, the absence of gas phase

reagents or products and, secondly, the fact that under normal conditions, the reagents and the cooled product are in a solid state.

We note that the regularities and the mechanism of combustion very strongly depend on whether or not at least one of the components of the mixture melts. Let us first consider the case when one of the reagents melts. As an example, it is convenient to take the SHS-system Ti-C, which is fairly well studied and at the same time is of practical interest. In Fig. 5 shows the dependence of the propagation velocity of SHS in mixtures of titanium and carbon on various experimental parameters (according to the data of V.M. Shkiro and I.P. Borovinskaya). First of all, we see that in a mixture of titanium and carbon, SHS is realized in a very wide range of concentrations. The most rapidly spreading wave of synthesis is the stoichiometric mix (mole of carbon per mole of titanium), while combustion is stationary, that is, the speed of advance of the SHS front over the sample is the same at any time. In the range of molecular ratios of C/Ti from 0.4 to 0.8, we are faced with a new phenomenon - self-oscillatory, or pulsating burning. In this scenario, the combustion wave moves along the reaction mixture as if by jerks - during a period of rapid combustion, the front should stop, then the cycle repeats. In more detail, we will consider this mode later for another system

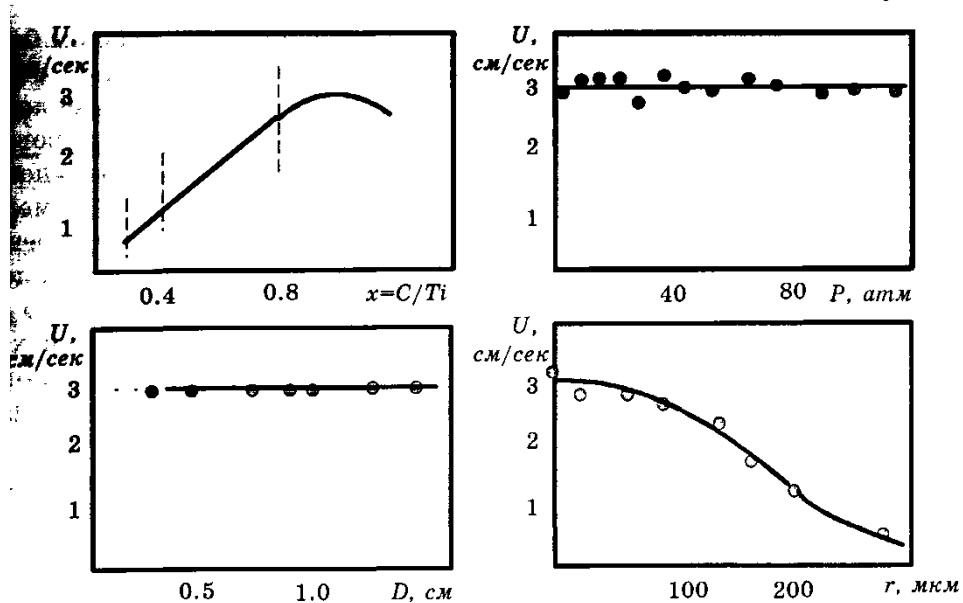

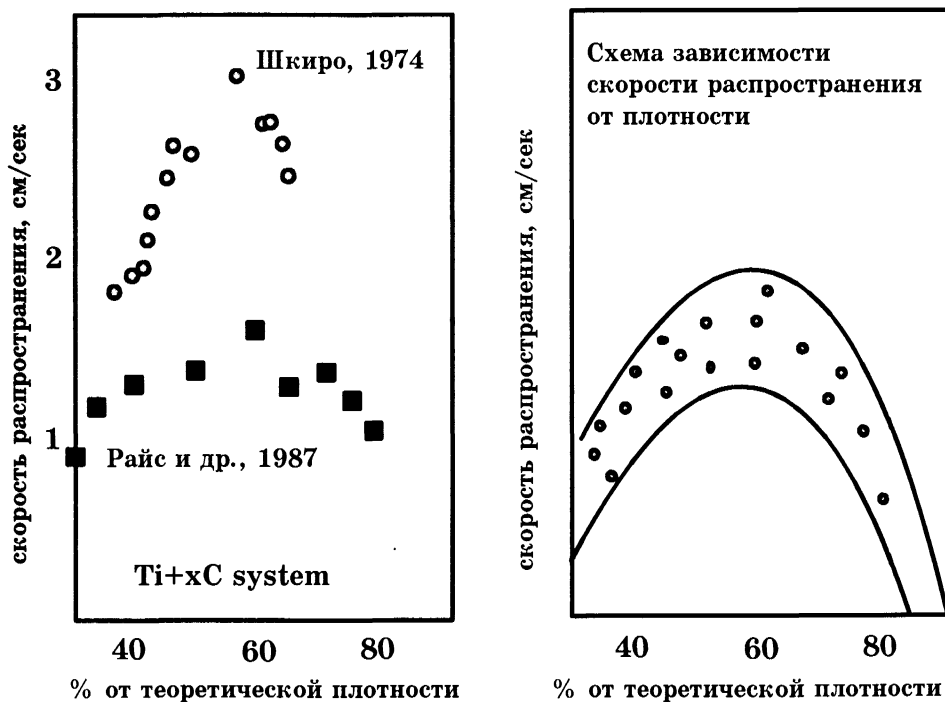

Fig. 5 Dependence of the burning rate in the Ti + xC system on the ratio of reagents (x), gas pressure (P), sample diameter (D), particle size of titanium (g), and relative density

At a molar ratio C/Ti, equal to 0.32, the burning limit is reached. The burning rate in the Ti + C system depends very little on the diameter of the sample. This is due to the high heat of reaction of titanium with carbon, which is significantly higher than the heat loss even for small sample diameters. However, for many other SHS systems, heat losses begin to affect the sample sizes of the order of 1 cm or less, leading to a decrease in the burning rate and non-combustion. The burning rate, as seen from the figure, does not depend on the pressure of the inert gas (Ar) in which the process is carried out. This is the main sign of the gas-free burning regime, when the raw materials and final products do not pass into the gas phase during the combustion process. (As will be shown later, this does not mean a complete absence of gas-phase processes in the medium over which the combustion wave propagates). Another dependence in Fig. 5 shows how the burning rate decreases with increasing particle size of the titanium. Interestingly, up to the particle size of 100 μm , the burning rate is practically constant. This ability becomes understandable when studying the mechanisms of interaction: it is explained by the spreading of liquid titanium in a combustion wave (we will

discuss this effect in more detail later). Let us emphasize once again that the type of dependence shown here is typical for many gas-free SHS systems, mainly only the absolute values of U .

In Fig. 5 also shows the dependence of velocity on the density of the mixture (V.M.Shkiro, I.L.Borovinskaya, 1975). As we see, this dependence has a maximum near the density of about 60% of the theoretical. An analogous dependence was obtained later by R. Rice and G. Richardson and co-authors. If the increase in the burning rate with increasing density is easily explained by the improvement of the contact between the components and the thermal conductivity of the hot product, then it is not so easy to explain the drop in the burning speed. Apparently, there is a sharp increase in the heat dissipation from the reaction zone to the initial reaction mixture. Rice and Richardson generalized the results of experiments with mixtures of titanium, carbon and/or boron in the form of the scheme shown in Fig. 5. Comparison of the patterns of combustion of various mixtures showed that the velocity of propagation of the SHS wave at the beginning increases with the density of the mixture, reaching a maximum in the range of 50 to 70% of the theoretical density, and then rapidly decreases with further increase Density. Samples with a high density (about 90% of the theoretical and higher) usually can not be ignited, or the burning in such mixtures decays. Determination of the optimal density for the spread of the SHS process within the range of 50-70% leads us to one very important conclusion in practice. Namely: when obtaining non-porous materials, the compaction stage (for example, hot pressing) must follow the SHS wave, since premature condensation of the medium can lead to extinction of the synthesis process.

We note the discrepancy in the absolute values of the velocity obtained by different authors. This discrepancy is not accidental. In Fig. 6 shows the dependence of the burning rate on dilution with the final product (TiC). The absolute values of the velocity obtained by different investigators differ several times, namely: the mixtures prepared by S. Dunmed and J. Holt and co-authors burn several times more slowly. Meanwhile, a comparison of the dispersions of reactants and other syn- thesis conditions allows us to rather expect the opposite effect: these mixtures should burn faster as more finely dispersed. Apparently, the whole point here is the thermo vacuum treatment, which is subjected to the reaction mixture by American researchers. This treatment consists in heating the sample before ignition to 500°C in vacuo with continuous evacuation for 5 hours, after which it is again cooled to room temperature. As a result of this treatment, impurity gases, mainly hydrogen, which are contained in the original powders (up

to 1% by mass) are removed from the mixture. The experiments carried out by us confirmed that degassing of the initial powders reduces the burning rate by several times. Thus, impurity gases, although they do not participate in the combustion reaction, still influence the reaction of the reagents. How does this happen? Apparently, we will be able to answer this question after considering the mechanisms of product formation in the SHS wave.

Continuing the scheme started, we first consider the mechanism of gas-free burning in systems with melting reagents, for example, the system-titanium plus carbon. The melting point of titanium is 1940K, that is, below the burning temperature, which for this system reaches 3000K and above. Consequently, titanium particles must melt in the combustion front.

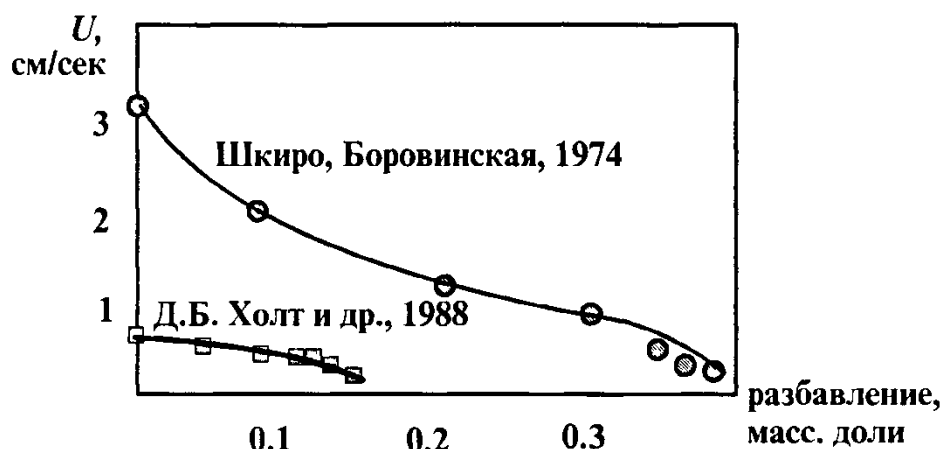

FIG. 6. The dependence of the combustion rate of Ti + C on the dilution with the final product

Research V.M. Shkiro and I.P. Borovinskaya showed that the melted titanium very quickly spreads over the surface of the carbon particles. Authors published in 1976, the work called this phenomenon a capillary spreading. The curves in Fig. 7 microstructures illustrate this effect. For clarity, titanium particles are of spherical shape. It can be seen that, after combustion, the pores remain in place of the metal particles formed as a result of the melting and decomposition of titanium. The shape and size of the pores correspond to the shape and size of the initial titanium particles.

The phenomenon of capillary spreading leads to a sharp change in the scale of heterogeneity of the reacting mixture from large titanium particles to very shallow

carbon particles (usually carbon black is used). This leads to a strong intensification of the combustion process and explains the seemingly at first sight nature of the high velocities of gas-free burning (which can not be explained from the point of diffusion saturation of titanium particles by carbon). Taking into account the capillary spreading leads us to understand that the driving force of the SHS process in the Ti+C system is the interaction of a carbon particle with a metallic melt. Different research groups differently approach the consideration of the mechanisms of this interaction, build the structure of the reaction cell differently.



Fig.5a. Capillary spreading (absorption) in the Ti-C system: initial mixture

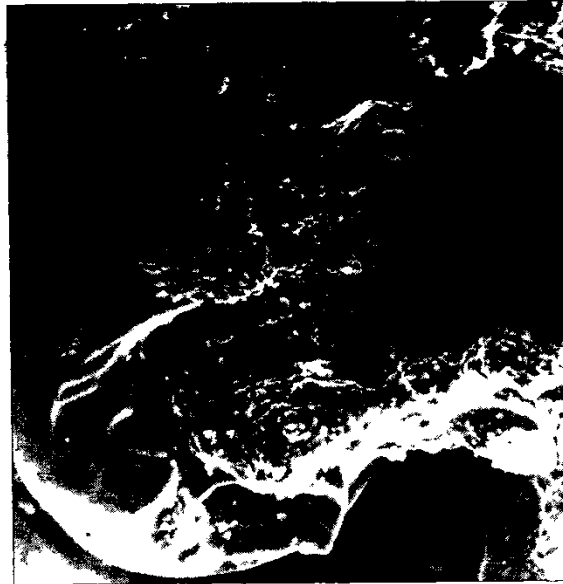

Fig.5b. Capillary spreading (absorption) in the Ti-C system: reaction zone

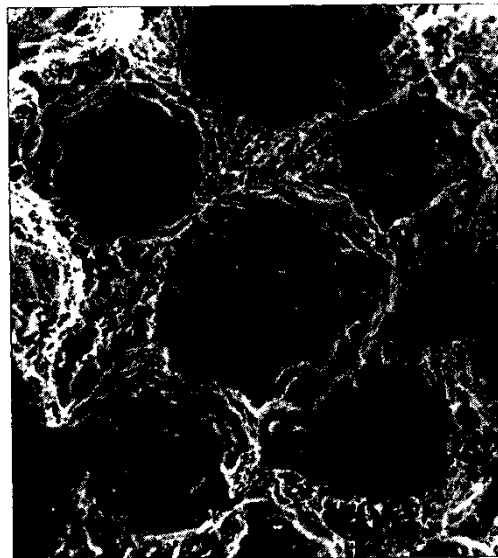

Fig. 5c. Capillary spreading (absorption) in the Ti-C system: product

In the works of Tomsk researchers (E.A. Nekrasov, V.K. Smolyakov, Y.M. Maksimov, 1981), a carbon diffusion scheme through the product layer is used to describe the reaction cell, which is used in metallurgy to describe the interaction of graphite with metallic swimming. This scheme is shown in Fig. 8. It is known that the coefficient of diffusion of titanium in titanium carbide is several orders of magnitude lower than the coefficient of carbon diffusion. Therefore, the flow of

atoms is directed in one direction - the carbon atoms diffuse through the layer of titanium carbide and then dissolve in the melt. The conditions on the boundaries of the layers are given in accordance with the titanium-carbon state diagram:

carbide composition along the carbon boundary is stoichiometric $TiC_{1,0}$; on the boundary with the melt corresponds to the solidus line, and the composition of the melt at the boundary with the carbide is determined by the liquidus line. Introducing a number of simplifying assumptions, the authors solved the system of diffusion equations together with the equations of the combustion wave on a computer. The obtained dependences of the propagation velocity of the combustion front on the ratio of the reagents, initial temperature, dilution - qualitatively agree with the experimental results. Thus, according to this model, the SHS product is formed as a carbide layer on the surface of the carbon particle, and the limiting stage of the process is the diffusion of carbon through this layer. But there is a natural question: how legitimate is the use of this model for microscopic carbon particles?

Indeed, in this model, nothing is said about the microstructure of the carbide layer. It is implicitly assumed that the polycrystalline structure of carbide can be ignored because the layer thickness exceeds the crystallite size many times over. This is true when it comes to relatively large particles of carbon material (of the order of 1 mm or more). If we consider

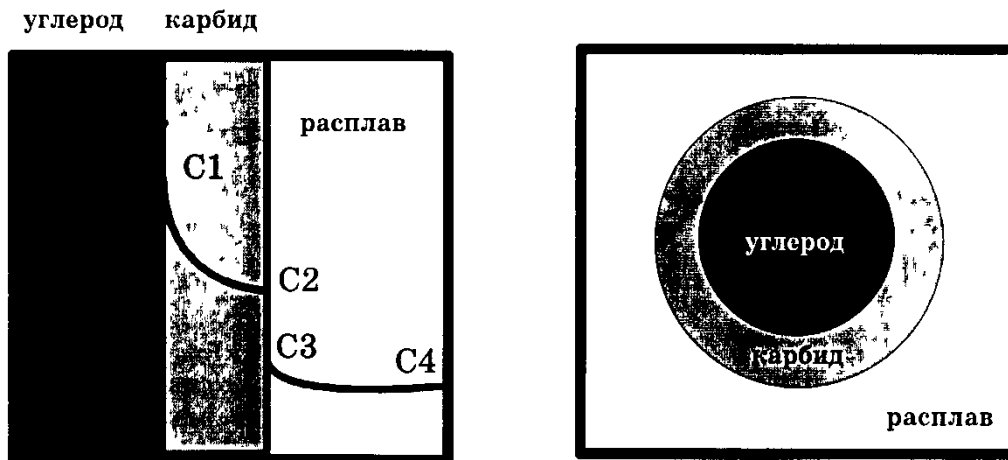

Fig6. Reaction cell layout

particles of carbon of the order of 1 micrometer or less, then the mechanism of action may be completely different. In Fig. 9 shows the interaction of thin carbon fibers with titanium melt (the fibers were used to obtain a more graphic picture). The diameter of the fiber is $6 \mu m$, which corresponds to the size of the

carbon particles at which the SHS reaction is possible. We see that the carbide layer on the surface of the fiber consists of only a few crystals of titanium carbide. Consequently, we must take into account the microstructure of this layer. It turns out that at such sizes of particles an important role is played, firstly, by the penetration of the melt along the grain boundaries and, secondly, by the so-called "arched effect", which can be explained as the "repulsion" of growing carbide crystals leading to the separation of the carbide layer from the surface of the carbon. Thus, the carbide crystals periodically break away from the carbon surface and pass into the melt, and new crystals are formed in their place. As a result, the thickness of the carbide layer never exceeds the dimensions of a single carbide crystal, and the microstructure of the product formed is fundamentally different from the previously considered model.

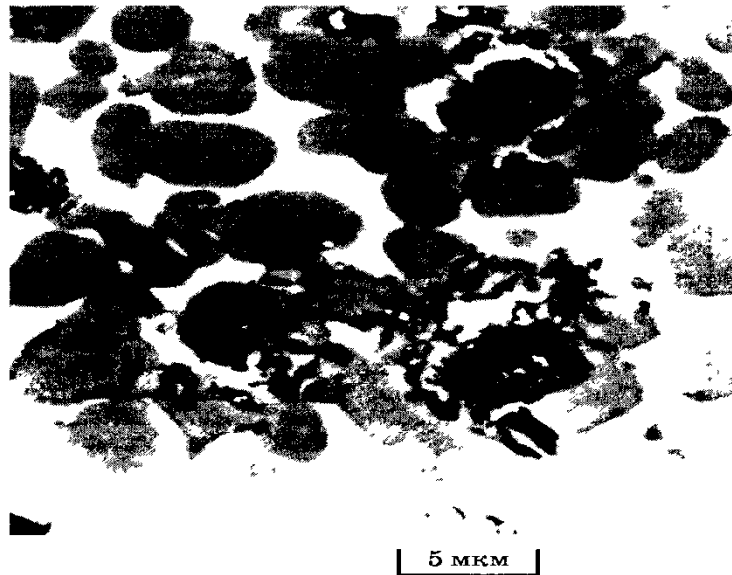

Fig.7. Interaction of carbon filaments with titanium melt

Finally, a case is possible where the carbide layer does not form at all—direct dissolution occurs. In the titanium-carbon system, the realization of this mode is possible with some excess of titanium and additional heating. For example, the conclusion about the direct solution of carbon was arrived at by V.A. Knyazik, A.G. Merzhanov and A.S. Steinberg in 1988, based on the analysis of experiments on the so-called electro-thermal explosion. This method is based on heating the sample by passing an electric current through it, until ignition, and recording the temperature of the sample in time. In the process of electrothermal explosion, the reaction proceeds uniformly over the volume of the mixture, as a result of which it becomes possible to quantitatively calculate the kinetic parameters from

experimental thermograms. Processing of thermograms of ETV allowed us to construct the dependence of the power of chemical heat release on the temperature of the sample. This dependence for the titanium-carbon system in the Arrhenius anamorphosis, as well as the results on the kinetics of the interaction in the titanium-graphite system, are shown in Fig. 10. It can be seen that at temperatures above the melting point of titanium, the reaction depends little on the temperature, that is, it is thermally inactive. Consequently, the diffusion of carbon in a solid carbide layer cannot be a limiting reaction stage, since this process is highly activated. In the opinion of the authors, the limiting stage at high temperatures is the dissolution of carbon in liquid titanium, since the dissolution processes in metallic melts are characterized by the absence of thermal activation and appreciable auto-inhibition.

A similar conclusion is about the transition of combustion to the regime of direct carbon dissolution. - was made by AI. Kirdyashkin, Yu.M. Maksimov and E.A. Nekrasov in studying the combustion of Ti+0.5C mixtures preheated to a temperature above 500°C. We will discuss these works in more detail when considering the effective kinetics of SHS processes.

Summarizing the above, I must say that the interaction of the refractory particle with the melt is possible in three modes: interaction through the growing layer of the product; The formation of this layer is also periodic; and direct dissolution in the melt without the formation of a solid product.

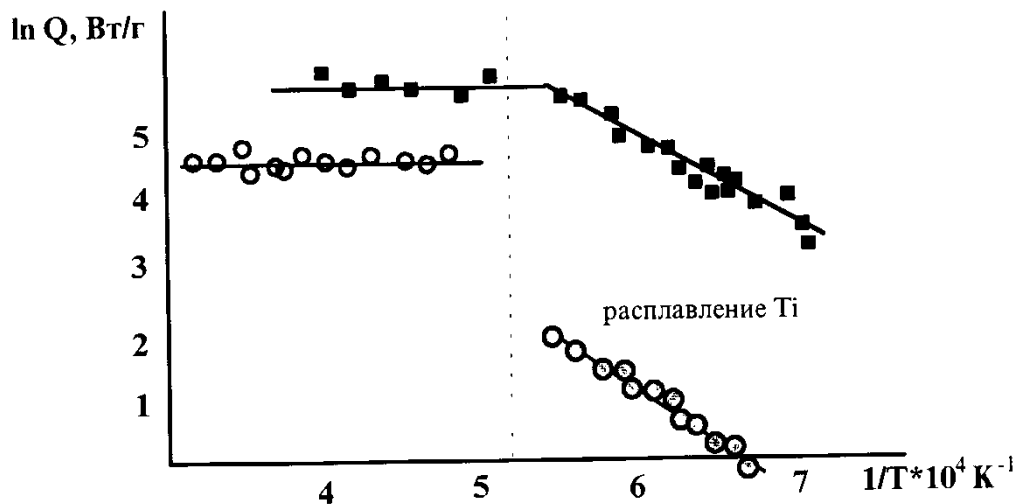

Fig. 8. Dependence of the logarithm of the rate of heat release on the reciprocal temperature for an electrothermal explosion (according to V.V. Knyazik, A.G. Merzhanova, A.S. Steinberg, 1988)

Let us now turn to the processes of gas-free combustion in systems in which none of the components or products melts down to the maximum combustion temperature. As an example, we will consider the tantalum+carbon system. The melting temperature of tantalum (3014°C), like the temperature of the Ta-Ta₂C eutectic (2840°C), is lower than the burning temperature of the mixture Ta+0.5C (2300°C). Therefore, it is clear that the main reagents and reaction product in the combustion wave are in the solid state. Some of the combustion laws of the Ta+C mixture are shown in Fig. 11 according to V.M. Shkiro with co-authors. In the entire range of the reagent ratio, combustion occurs in an autooscillatory mode, therefore, along with the average velocity, the frequency of the velocity oscillations is indicated, that is, the number of flashes and depressions per second. The maximum of the burning rate is due to the molar ratio $\text{C}/\text{Ta}\approx 0.8$. In this case, the absolute values of the burning rate U are about an order of magnitude smaller than the Ti + C system. The "gas-free" combustion regime, when the velocity does not depend on the pressure of the inert gas, occurs, as can be seen from the figure, at comparatively high pressures. We also note the high (in comparison with Ti + C) sensitivity of the burning rate to the heat loss level, which is determined by the change in the diameter of the sample. Only when the diameter of the sample is about 2.0 cm, the dependence of the burning rate goes to the "plateau", that is, the heat losses become insignificant in comparison with the heat release. The critical diameter for the Ta+C mixture is 0.7 cm - samples with a smaller diameter do not burn.

On the dependence of the burning rate on the relative density, there is only a falling branch of the dependence. This result seems less unexpected, if we recall that in systems with a melting reagent, the onset of a decrease in velocity is associated with the transition of combustion into an autooscillator regime.

The obvious absence of melting, capillary spreading and similar effects, it would seem, should simplify the mechanism of interaction in the solid-solid systems. Interaction of reagents is possible only by solid-phase diffusion. Indeed, such a combustion mechanism is realized, but under two conditions: the particle size of tantalum and carbon should be of the order of one micrometer; and there must be a very good contact between the reagent particles (for example, the Ta particles are carbon-house clad). But in real mixtures, these conditions are often not met, but the burning takes place. The carried out researches have shown that in real systems the mechanism of interaction is rather complicated and involves, at least in some stages, not only solid-phase diffusion. Honestly speaking, we still do

not fully understand why the SHS process takes place in those systems where there is no melting of even one component. Nevertheless, we try to give some considerations. As it became clear from the study of the microstructure of SHS products in the Ta-C system, carbide formation occurs over the entire surface of the taneal particles, and not only

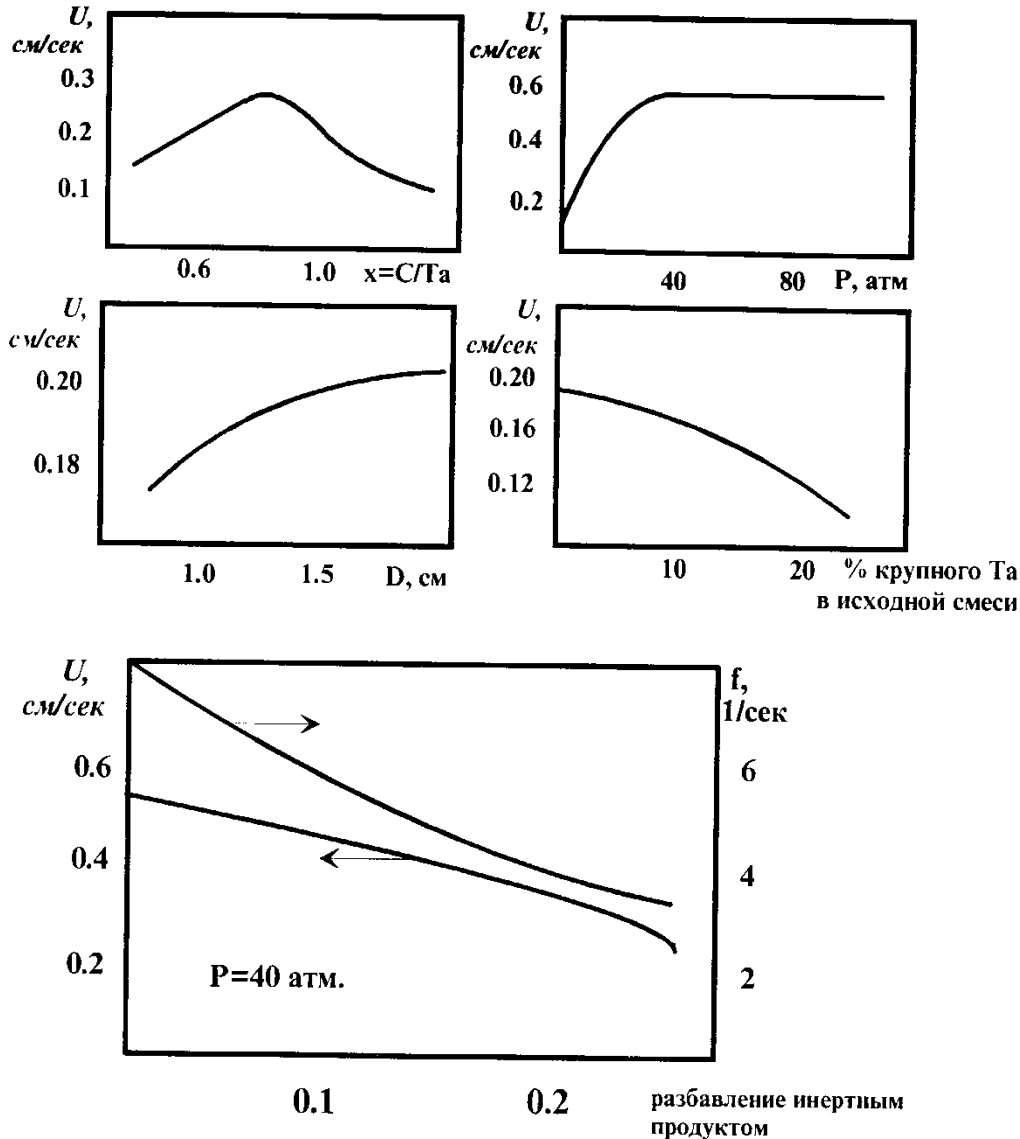

Fig. 9. The dependence of the combustion rate of the system Ta + xC on the ratio of the reagents (x), the gas pressure (P), the diameter of the sample (D), the content of coarse tantalum in the mixture and dilution (V.M. Shkiro etc.).

in places of its direct contact with carbon. This suggests that there is a transfer of carbon to the tantalum surface through the gas phase. Direct experiments confirmed these assumptions. Inside the sample, pressed from the Ta+C mixture,

small cavities (1-2 mm in diameter) were made into which a tantalum filament (50 mm in diameter) was placed without contact with the walls of the cavities. After the passage of the SHS wave on the surface of the filament, a product with a characteristic microstructure was formed. The surface of the filament acquires a golden hue, typical of TaC monocarbide. A similar microstructure was observed in a "frozen combustion wave." Here, this microstructure is formed at the low-temperature boundary of the reaction zone, then it passes into a globular structure, so that carbon is transported through the gas gap to the surface of the tantalum. Taking into account that tantalum powder contains 0.3% of oxygen, and carbon material - from 0.4 to 2.0% of oxygen, it can be assumed that the transfer takes place through carbon oxides of CO and CO₂. Thermodynamic calculations and kinetic About The prices showed that the transfer can occur according to the scheme illustrated in Figure 10:

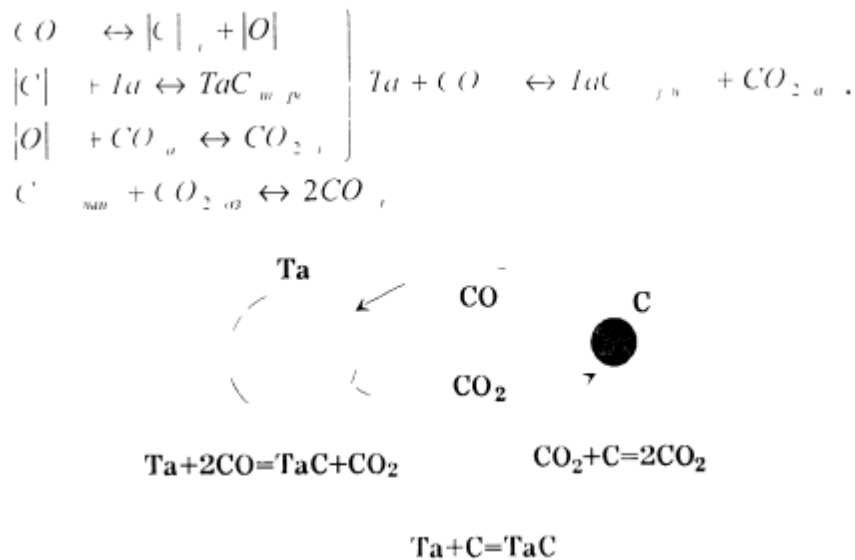

Fig. 10. Scheme of the gas-phase mechanism in the tantalum-carbon system

The first three elementary acts occur on the surface of tantalum and give a total gross reaction for the formation of TaC and CO₂. The flow of this reaction in the forward direction is possible due to the fact that carbon dioxide CO₂ is removed from the surface of the tantalum and is restored on the carbon surface by the Boudouard reaction. We note that, although the proposed scheme explains the mechanism of carbon transfer to the surface of tantalum, it does not eliminate the need for solid-phase diffusion through the layer of the reaction product. In other words, the gas-phase transfer realizes one of the conditions for solid-phase

combustion-a good contact of the reagents. The second condition - small particle sizes - is achieved using metal powders with a very developed surface. The tantalum powder used in SHS processes has a specific surface area of about 0.6 m²/g, which would correspond to a particle size of less than 1 μm if all the particles were spherical.

Of course, the mechanism of gas transfer of carbon can appear not only in the system Ta + C. For example, S. Adashi, I. Miyamoto and co-authors proposed this mechanism for burning titanium mixtures with carbon fibers. The basis for this assumption is the presence of a gap between the surface of the carbon filament and the layer of titanium carbide surrounding this filament (the diameter of the carbon fiber is 7 μm). Gaseous transfer is also possible in other systems, but a comparison of the transport rates of reagents as a result of spreading of the melt and gas-phase transfer shows that in those systems where one of the reagents melts and spreads over a finely dispersed hard melting reagent, do not play a significant role in the formation of the product of the reaction. On the contrary, the gas-phase transfer begins to manifest itself noticeably in the absence of intense melting.

In conclusion, let us say a few more words about the composition of the gases formed in the SHS processes. As shown by experiments, when burning condensed mixtures of metals and non-metals, the main components of the gas phase filling the pores of the burning sample are water and CO. In Fig. 13 shows the relative amount of H₂ and CO, formed during the combustion of various systems. It is logical to assume that the gas-phase transfer of carbon occurs in systems that burn off a large amount of CO and relatively low H₂.

Gas evolution in SHS

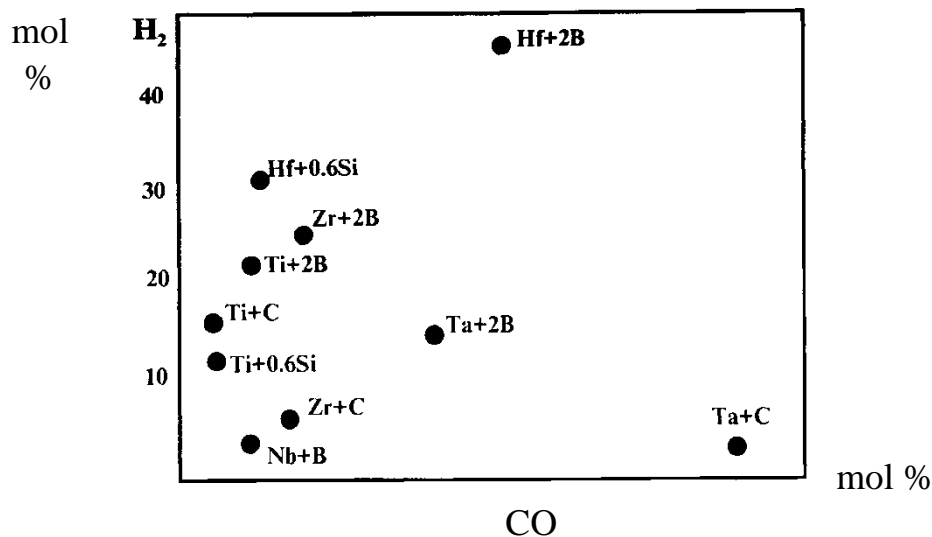

Fig. 11. Relative content of hydrogen and carbon monoxide in gaseous different products formed during SHS

As we see, this assumption does not contradict the experimental data. The large amount of hydrogen released during combustion of many mixtures affects not only the combustion mechanism (as we saw earlier) but also the formation of the porous structure of the products. This influence has been studied at the present time insufficiently. More research is required if we want to have a reliable way of obtaining materials with controlled porosity, including absolutely non-porous materials, in the SHS mode.

2.2. Solid-gas systems

Filtration combustion - a very broad concept, covering a large range of industrial processes and natural phenomena. For example, the greatest amount of work on the modeling of filtration combustion was carried out with reference to the in situ smelting of oil-saturated rocks. The objects of filtration combustion include blast furnace smelting of cast iron, burning and agglomeration of ores, regeneration of catalysts by burning coke deposits. However, as an independent section in the science of combustion of the theory of filtration combustion, it was formed precisely in the course of research into the processes of self-propagating high-temperature synthesis. Two circumstances contributed to this. First, in the filtration variants, the SHS process of filtration. The end result of the process itself. Spatio-temporal characteristics of the combustion waves in SHS-systems make it possible to conduct their all-round laboratory research (in contrast, for example, from the burning of oil-bearing strata). The second circumstance, which distinguishes SHS studies of filtration combustion, is due to the fact that these studies were conducted from the very beginning with the ideological and methodical positions of the classical theory of combustion. So, we will consider filtering combustion in SHS systems.

By definition, filtration combustion is a propagation of an exothermic transformation wave in a porous medium during gas filtration. One of the reagents is itself this porous medium, which is usually obtained by pressing the powder of the corresponding composition. It can be a metal powder, silicon, boron, alloy or compound - depending on the particular problem being solved. As a second reagent (oxidant), a gas atmosphere appears in which a porous sample is placed.

The composition of the gas determines the composition of the SHS product: nitrides are produced in nitrogen, hydrides in hydrogen, oxides in oxygen, and carbides in CO and CO₂; and so on. The filtration of the gaseous reagent into the reaction zone of the combustion wave can be organized in various ways, as shown in Fig. 12. In practice, the first option is probably more often used than others, when a sample with a fully exposed surface is placed in a gaseous oxidant environment. The filtration is carried out both through the initial mixture and through the combustion products. This variant is the most difficult for theoretical analysis, since the structure of the combustion wave is essentially three-dimensional. Therefore, in laboratory conditions, three other options are often used, based on armoring part of the sample surface with a gas-impermeable shell. In this case, a flat combustion wave with a one-dimensional structure is realized, and the supply of the gaseous reagent to the reaction zone can be carried out either by means of a wake-up filtration, or by counter-filtration through a condensed reagent, or, finally, by two-way filtering.

The mathematical model of filtration combustion, even in the simplest one-dimensional formulation, must take into account a large number of real processes: the heterogeneous interaction of condensed fuel with an oxide-fuel; the difference between the temperatures of the gas and the condensed phase; heat exchange in the gas phase, in the porous medium and between them, the difference in the concentration of the oxidant on the reaction surface and in the volume, etc. In the approximation of a single-temperature model (the temperature of the gas and condensed phases are equal), in the case of gas filtration, is given by the following system of equations.

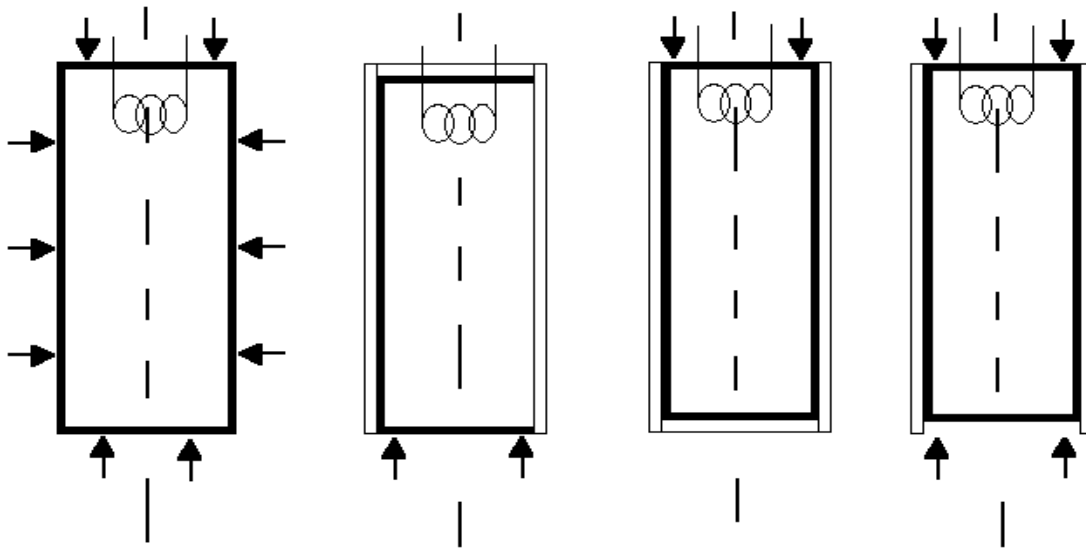

Figure 12. Schemes of gas filtration in the solid-gas system

Many interesting features of filtration combustion are associated with the mechanism of filtration of the gaseous oxidant. Distinguish between natural and forced filtration. In the first case (natural filtration), the pressure drop necessary for the gas flow is formed as a result of gas absorption in the reaction zone. For example, in the synthesis of aluminum nitride, each gram of metal binds half a gram of nitrogen. Can such an amount of gaseous oxidant be present in the pores of the original sample? As we shall see later, such a regime is implemented in some systems, but it requires the use of very high gas pressures (thousands of atmospheres).

At pressures of tens or even hundreds of atmospheres, the formation of condensed products (nitrides, oxides, etc.) is possible only if the gas is continuously supplied from the external medium to the reaction zone. And the speed of this approach is regulated by the chemical reaction itself: if the gas is bound to the condensed product very quickly, the pressure in the reaction zone can drop to almost zero, and gas from the external environment is intensively directed into this zone. If the reaction is slow, the pressure difference is smaller, and the flow is oxidized to the reaction zone, respectively. Thus, as in other SHS systems, we are dealing with a self-organizing process, the characteristics of which can be unambiguously determined by regulating the experimental parameters (particle size, gas pressure, dilution, porosity, etc.).

Additional methods for controlling the SHS process are provided by the method of forced gas filtration. In Fig. 13 shows the case of one-dimensional burning of a porous medium with forced purging of an oxidant or an inert gas through combustion products (sputtering filtration). The blowing speed is set by some external device and does not directly depend on the kinetics of the reaction. Analyzing this model, A.P. Aldushin and B.S. Sepiarski (1978) came to the conclusion that there are two interesting propagation modes and the corresponding combustion wave structures. In one regime, a normal propagation of the flame takes place, but with an abnormally high (super-adiabatic) combustion temperature. In this mode, the filtering gas takes heat from the combustion products, increasing the combustion temperature. If the speed of the blowing-up increases even more, a second burning mode may arise-with an anomalously wide heated layer and a quick filling of the products of the burning. In this case, heat is taken not only from combustion products, but also from the reaction zone, so the

burning temperature in this case is below the adiabatic temperature. The authors called this regime "inverse wave of burning".

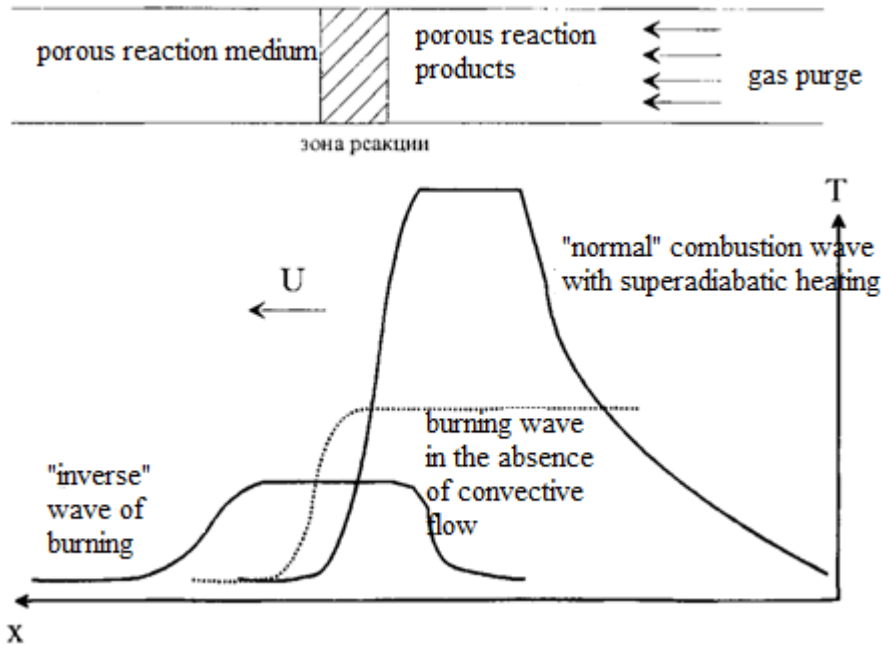

Fig. 13. Normal and inverse combustion waves when a gas is blown through a porous medium

Experimental studies of filtration SHS processes led to the discovery of a number of very interesting phenomena. Consider some of them. In the study of combustion of compressed samples of metal in nitrogen in 1973, A.G. Merzhanov, A.K. Filonenko and I.P. Borovinsky found that under certain conditions, after ignition of a cylindrical sample on its lateral surface, a bright spot of a small diameter appears that moves along the lateral surface of the unburned part of the sample along a spiral leaving a bright trace of up-burning, Blending with the same trace from the previous coil. In Fig. 14 shows a kinogram of such a process, called the spin combustion. It can be seen that the source of pressure is due to the invisible side of the cylindrical sample, moving across the main direction of combustion and disappearing from the field of vision.

The direction of rotation of the spot (to the right, to the left) is arbitrary. Sometimes there are several spots moving in one direction or towards each other, disappearing and arising again.

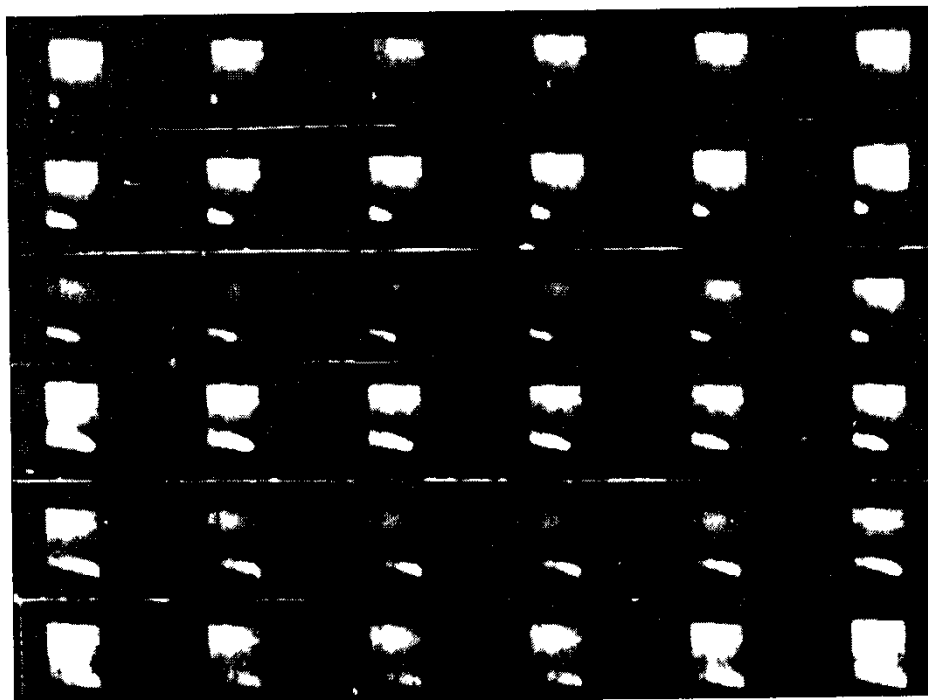

Fig. 14. Film frames for spin burning of hafnium in nitrogen

An interesting effect of the bifurcation of the flat front of filtering combustion was established by A.N. Pitulin and I.P. Borovinskaya with with co-authors. As is clear from the scheme shown in Fig. 15, they studied the burning of cylindrical specimens with an armored side surface. The effect of bifurcation is that a light-luminous front separates from a brightly shining front, which, with acceleration, "escapes" from the main front. The study of quenched samples showed that incomplete conversion of reagents occurs in the first combustion front (Fig. 16). Under certain conditions, this effect is observed in the systems Ta-N₂, Ti-N, Hf-N. The propagation of a flat combustion front in filtration SHS systems (they are called hybrid or solid-gas systems) is possible without reservation of the sample surface. From this point, mention should be made of the work of AS Mukasyan and his co-authors (1985) on the combustion of porous boron samples in nitrogen at pressures from 100 to 2,000 atm (2.0 kbar). At pressures above 500 atm of nitrogen contained in the pores of the sample, it is sufficient for the distribution

of the front, as shown in Fig. 17. The depth of transformation in this front is less than one, but this value is constant throughout the sample. And only after passing the combustion front and practically complete nitrogen uptake in the pores, a relatively slow wave of overgrazing begins to propagate from the lateral surface of the aggregate due to the filtration of nitrogen from the external environment. The maximum combustion temperatures in the B-N₂ system depend on the nitrogen pressure, this dependence is also shown on the slide. Absolutely unusual and even paradoxical patterns of combustion are observed in the system of silicon-nitrogen. In Fig. 17 are given, according to AS. Mukasyan, depending on the speed and temperature of silicon burning in an atmosphere of nitrogen, depending on the degree of dilution of the final product, silicon nitride. As we see, the temperature of combustion does not change when the reaction medium is added with an inert, and the burning rate even increases.

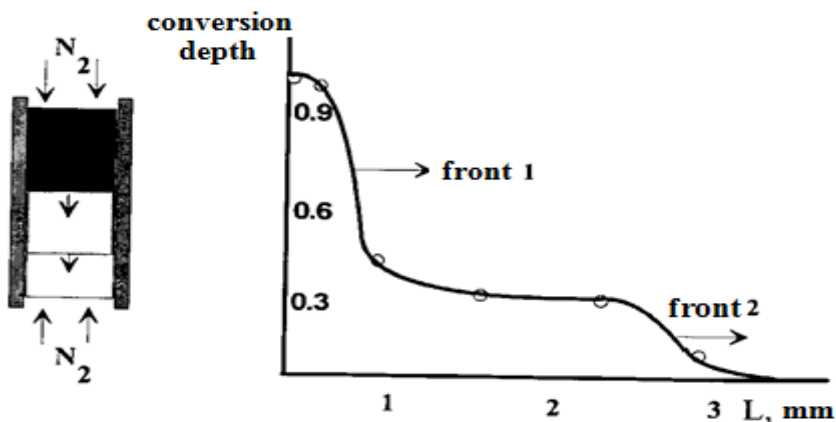

Fig. 15. Formation of two fronts in the combustion of tantalum in nitrogen

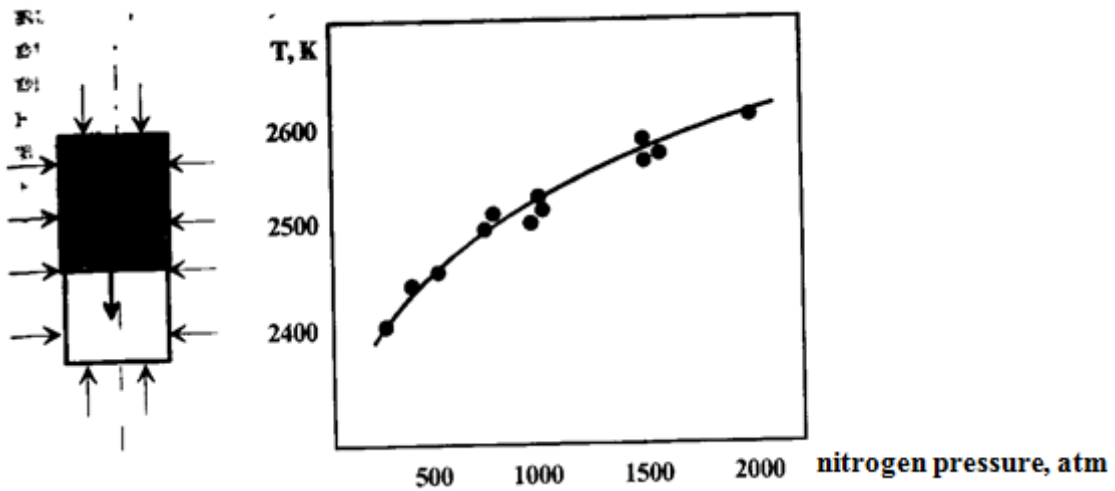

Fig. 16. Features of combustion of boron in nitrogen: frontal combustion and filtration after burn fronts in the sample and the dependence of the combustion temperature on the pressure of nitrogen

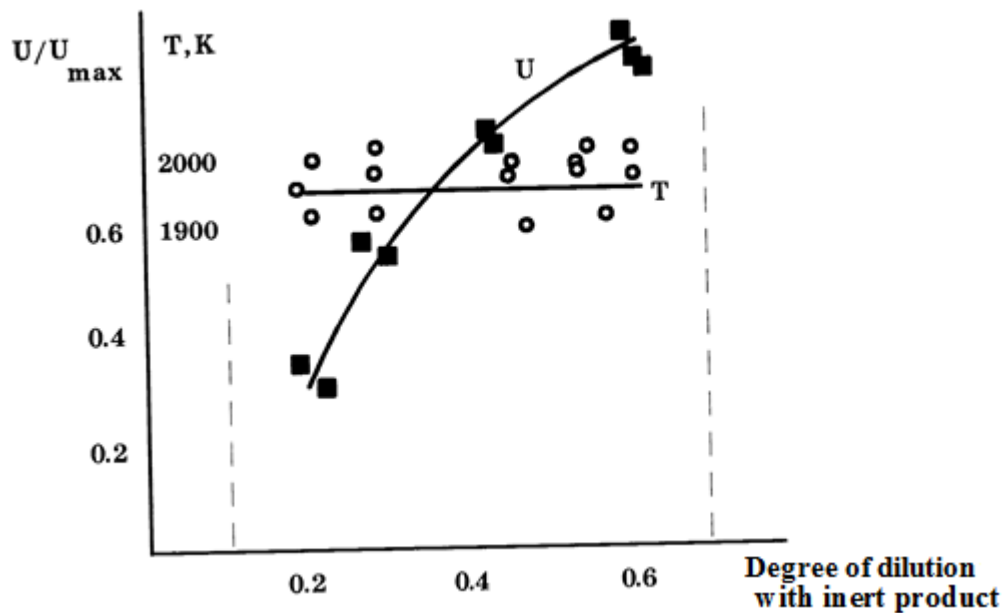

Fig. 17. The dependence of the speed and temperature of silicon burning in nitrogen on diluting the silicon powder with a final product (silicon nitride)

The analysis showed that the stability of the combustion temperature is explained by the intense dissociation of silicon nitride at a temperature of about 2,200 K. The process of dissociation prevents further product formation and temperature growth. The leading temperature is the temperature of dissociation of Si_3N_4 , and the reaction depth in the reaction zone is much less than unity. It is easy to see that the addition of silicon powder with an inert metal leads only to an increase in the depth

of the transformation in the reaction zone, since the formation of the product proceeds until the entire medium is heated to the temperature of intense dissociation. Such a combustion regime is described by a combustion model with high-temperature dissociation. But this model does not explain the increase in the burning rate. To understand this effect it was possible only after studying the microstructure of the "frozen" SHS wave and taking into account the melting of the solid-phase reagent in the heating zone. It turned out that the particles of silicon melt and coagulate in the heating zone of the SHS wave, which significantly slows down the reaction and reduces the burning rate. Dilution with the final product prevents coagulation, which explains the increase in the burning rate.

Coagulation of silicon droplets can lead to the formation of even microscopic silicon films that block the filtration of nitrogen and convert combustion into an auto oscillatory mode. In this case, the product consists of alternating layers of silicon nitride and elemental silicon. The former is formed as a result of combustion during a flare, and the adjacent silicon layer has not reacted with nitrogen due to the intense coalescence that took place during the depression.

The limited scope of this book, unfortunately, does not allow us to consider the patterns of combustion with other gases - hydrogen, oxygen, carbon oxides, although they are of no less interest. We must now proceed to consider the mechanisms of reactions in the SHS wave involving a gaseous reagent.

The proposed mechanisms of combustion of transition metals in nitrogen have much in common with the mechanisms of interaction in metal-carbon systems. Recall that the formation of carbides can occur both by increasing the carbide layer at the interface, and as a result of direct dissolution of carbon in the metal with subsequent crystallization. For systems of the metal-gas type and the like, back in 1975, I.P. Borovinskaya proposed and experimentally substantiated the mechanism of propagation of the SHS wave due to the direct saturation of metallic particles with nonmetal (nitrogen, hydrogen, boron, etc.), without the formation of a phase of the final product of the refractory compound. The final product is formed already in the zones of burnout of the structure formation. Along with this, a mechanism can be realized for the interaction of a gas with a metal through a layer of the final product. Intensive integration of these mechanisms for the Ti-N₂ system was proposed in paper Munir et al. They showed that in the first stages of interaction of the reagents a very rapid formation of a layer of nitride up to a few micrometers thick occurs, but the heat release during the formation of this layer leads to combustion. But then, in the afterburning zone, not the growth occurs, but the dissolution of the nitride layer in the metal phase, leading to bulk saturation of

titanium with nitrogen. The final titanium nitride crystallizes in the volume of the melt.

Perhaps, in the most "pure" form the mechanism of direct dissolution of a gaseous reagent in a metal is carried out during combustion in water. This combustion occurs frequently under conditions of very strong dissociation. In this case, not a hydride is formed in the wave, but only a solid solution of hydrogen in the metal, while the completeness of hydrogenation is only 20%. Studies conducted by S.K. Dolukhanyan and M.D. Nersesyan et al., Showed that the hydride phase is formed when the sample cools due to a shift in equilibrium. Such a mechanism is explained by the extremely high diffusion mobility of water in metals.

A fundamentally different mechanism of interaction takes place in the formation of nonmetallic nitrides, for example, Si_3N_4 , in the SHS wave. For a silicon-nitrogen system, bulk nitriding of silicon particles is impossible due to the negligible solubility of nitrogen in both solid and molten silicon. Therefore, the formation of the product takes place on the surface of the condensed particles. However, the mechanism of nitride film growth, through which nitrogen diffuses, does not allow to explain the observed nitride formation rates. Estimates show that the thickness of the nitride layer, which can be formed by this mechanism, does not exceed $0.5 \mu\text{m}$, which is much less than the Si_3N_4 crystals actually formed in the SHS wave. In the works of A.S. Mukasian and BV Stepanova et al. (1990) proposed the following SHS mechanism in the silicon-nitrogen system. The Si_3N_4 crystals in the reaction zone grow according to the vapor-liquid-crystal (FFA) mechanism. The micromorphology of the final and quenched reaction products speaks in favor of this mechanism. Usually the product is represented by columnar crystals with a pronounced shape, often twinning of crystals. The transfer of silicon to the growing face of the crystal is due to the evaporation of silicon. The rate of evaporation and gas-phase diffusion of silicon vapors, according to the estimates of the authors of this mechanism, ensures the growth of Si_3N_4 crystals with a speed of the order of $1 \mu\text{m} / \text{s}$, which corresponds to the experimental results. Realization of the mechanism of FFA is facilitated by the presence of a small amount of Fe, Ca, Zn, Al impurities. These impurities form stable droplets of eutectic melt with silicon, which are the centers of nucleation of the product and accelerate the process of nitride formation.

3. Thermodynamics and kinetics of SHS reactions

After initiation, the SHS process proceeds self-sufficiently without any external energy sources. Consequently, the driving force of the process should be sought in the SHS system itself. What is this driving force? The simplest and most obvious answer is that the driving force of the process is to reduce the internal energy of the system, more precisely, by conversion of its chemical potential into heat. In general this is true, but it does not reflect all the specifics of the thermodynamics of the SHS. To understand these particular features, one needs to analyze the different structural levels of reactive systems.

Let us first consider the SHS system as a whole, on a macroscopic scale, under the assumption that the interaction with the surrounding environment can be neglected. Conditions in which there is no exchange of heat between the considered system and the environment are called *adiabatic conditions*. If in addition the amount of matter in the system remains constant, the system is called the *isolated system*. So, assume that a reaction mixture consisting of the powder particles of the solid reagents is placed in a sealed adiabatic vessel (optionally the vessel may also contain a gaseous or liquid reagent). It is experimentally confirmed that at room temperature such an initial mixture can typically exist indefinitely long, without noticeable changes in composition, microstructure, temperature or pressure. The condition in which the system does not change its characteristics over time is called the *stationary state*. However, such an initial stationary state of the SHS system is 'deceptive'. If the temperature of the system is raised to the point at which the mutual diffusion of the reagents could occur at an appreciable rate, a chemical reaction with heat generation starts in the vessel. As a result of the exothermic reaction, the temperature in the vessel increases even more, which in turn leads to an increase in the reaction rate, i.e. the process becomes self-accelerating. This process stops when the reagents are completely transformed into the reaction products and the system reaches a new steady

To conduct SHS processes, it is necessary that a large amount of heat be released during the synthesis. This heat warms the reaction zone to a high temperature and supports the propagation of the combustion wave. The natural question arises: how much the use of the SHS method is to the extent that it is a requirement. After all, not every reaction is accompanied by heat generation, therefore, not every product can be obtained in the SHS mode. Therefore, at the very beginning of the research, more than 20 years ago, any new experimentally found SHS-system aroused increased interest. When the number of these systems

exceeded a few dozen, it became obvious that there is a certain pattern, and it is necessary to conduct a wide-scale search for systems capable of reacting in the SHS mode. This became one of the first tasks of the thermodynamics of SHS processes.

The most reliable way to predict the possibility of SHS in any mixture is to calculate the adiabatic temperature of combustion of this mixture. This temperature must be high enough to provide an intense heterogeneous reaction. It is desirable that the adiabatic combustion temperature is above the melting point of at least one of the components. Let us briefly consider the methodology and results of calculating the combustion temperature. Calculation of the combustion temperature of a mixture of various elements and compounds is carried out, as a rule, under the assumption that the process is adiabatic (no heat loss from the reaction zone) for the case of complete conversion of the reactants. Processes leading to incomplete transformations — dissociation of reaction products or under-burning of the starting materials — can also be incorporated into the thermodynamic calculation model and taken into account. The main condition for calculating the adiabatic combustion temperature T_{ad} is the equality of the enthalpies of the starting materials at the initial temperature T_0 and the final products at the temperature T_{ad} :

$$\sum_{i=1}^n [H(T_{ad}) - H(T_0)]_i = Q,$$

(where T_{ad} is the adiabatic combustion temperature, T_0 is the initial temperature, Q is the thermal effect of the reaction, summation is conducted over all reaction products) means that all the heat released during the reaction goes to heat the combustion products from the initial temperature T_0 to the combustion temperature T_{ad} .

In the simplest case, a single reaction product formed from the elements: Equation (19) can be represented as

$$\int_{T_0}^{T_{ad}} c(T) = Q - \nu L, \quad (20)$$

where $c(T)$ is the heat capacity of the product, L is the heat of fusion, and ν is the fraction of the liquid phase in the combustion product. The last term takes into account the proportion of heat consumed to melt part or all of the final reaction product. The values of $c(T)$, Q and L are found from reference data. Usually, the

value of T_{ad} is found from the solution of equation (20). Using the expression for the average heat capacity and the thermal effect of the process

$$\bar{c} = \frac{1}{T_{ad} - T_0} \int_{T_0}^{T_{ad}} c(T) dT; \quad \bar{Q} = Q - \nu L, \quad (21)$$

can be written as

$$T_{ad} = T_0 + \frac{\bar{Q}}{\bar{c}}. \quad (22)$$

This relatively simple method of calculation was used by N.P. Novikov, I.P. Borovinskaya and A.G. Merzhanov (1975) for estimating the temperatures of SHS processes from elements, with his help, a large number of systems were analyzed. In a number of works of SS. Mamyán, I.P. Borovinskaya and A.G. Merzhanova used a more general approach, which considers the chemical and phase equilibria in multi-component combustion products and allows us to calculate not only the combustion temperature, but also the composition of the products. For gasless combustion with a single-phase product, both approaches give the same result.

Table 1 shows the results of calculating the T_{ad} of some borides. As you can see, some combustion temperatures are quite high and lie in the range of 1400-3500 K. The highest T_{ad} for the reactions of formation of metal borides of group IV of the periodic system, ongoing to metals of groups V and VI they decrease. The heat release (specific) of the corresponding reactions also falls in this series.

Table 1 Adiabatic SHS temperatures of some borides

Combustion reaction	$T_{ad.}, K$
Ti+B=TiB	3350
Ti+2B=TiB ₂	3190
Zr+2B=ZrB ₂	3310
Hf+2B=HfB ₂	3520
Nb+2B=NbB ₂	2400
Ta+2B=TaB ₂	2700
Mo+B=MoB	1800

The calculated burning temperatures of mixtures of metals with carbon are listed in Table 2. The highest combustion temperatures, as in the case of borides, correspond to reactions involving metals of the IV group, in the transition to metal carbides, the T_{ad} of the Tad group decreases. For some carbides (B_4C , SiC , WC), the adiabatic temperature is so low that it is doubtful whether the corresponding mixtures can burn. To obtain these carbides by the SHS method, it is necessary either to preheat the reaction mixture or to change the reaction scheme.

Table 2 Adiabatic SHS temperatures of some carbide

Combustion reaction (SHS)	T_{ad} , K
$Ti+C=TiC$	3210
$Zr+C=ZrC$	3400
$Hf+C=HfC$	3900
$Nb+C=NbC$	2800
$2Ta+C=Ta_2C$	2600
$Ta+C=TaC$	2700
$Si+C=SiC$	1800
$4B+C=B_4C$	1000

The results of calculating the adiabatic temperatures of the reactions of nitride formation are interesting (Table 3). Very high temperatures are explained not only by the high heat of nitride formation, but also by the fact that the dissociation of the products was not taken into account in the calculation. The degree of dissociation and, consequently, the combustion temperature should depend on the nitrogen pressure P_{N_2} . The results obtained without disassociation are related to the limiting case $P_{N_2} \rightarrow \infty$. Experimental measured temperatures of combustion in filtration systems, as we have seen in the last lecture, are much lower than the adiabatic ones. For example, the burning temperature of silicon in nitrogen at medium nitrogen pressures is 2200-2400 K and is limited by the

dissociation of Si_3N_4 .

Table 3 Adiabatic temperatures of SHS of some nitrides (without dissociation)

Combustion reaction (SHS)	T_{ad} , K
$\text{Ti} + 0.5\text{N}_2 = \text{TiN}$	4900
$\text{Nb} + 0.5\text{N}_2 = \text{NbN}$	3500
$\text{Ta} + 0.5\text{N}_2 = \text{TaN}$	3360
$3\text{Si} + 2\text{N}_2 = \text{Si}_3\text{N}_4$	4300
$\text{B} + 0.5\text{N}_2 = \text{BN}$	3700
$\text{Al} + 0.5\text{N}_2 = \text{AlN}$	2900

For some other systems, the calculated combustion temperatures are given in Tables 4 and 5. Comparison of the burning temperature of the formation reactions of different classes of compounds shows that the largest T_{ad} are observed when nitrides are formed, the smallest are the silicides. Carbides and borides occupy an intermediate position. In those cases when the heat release in the synthesis from the elements is not sufficient for the propagation of the combustion wave, synthesis with a reducing stage - from oxides or other compounds is possible. In some cases, use an additional metal-reducing agent - that is, the SHS process includes a metal stage.

Table 4 Adiabatic SHS temperatures of some silicides

Combustion reaction (SHS)	T_{ad} , K
$5\text{Ti} + 3\text{Si} = \text{Ti}_5\text{Si}_3$	2500
$\text{Ti} + \text{Si} = \text{TiSi}$	2000
$5\text{Zr} + 3\text{Si} = \text{Zr}_5\text{Si}_3$	2800
$\text{Ta} + 2\text{Si} = \text{TaSi}_2$	1800
$\text{Mo} + 2\text{Si} = \text{MoSi}_2$	1900

Table 5 Adiabatic combustion temperatures of some SHS systems using compounds as starting reagents

Combustion reaction (SHS)	T _{ad} , K
$3\text{TiO}_2+10\text{B}=3\text{TiB}_2+2\text{B}_2\text{O}_3$	1400
$6\text{WO}_2+11\text{B}=3\text{W}_2\text{B}+4\text{B}_2\text{O}_3$	2400
$\text{WO}_3+3\text{B}=\text{WB}+\text{B}_2\text{O}_3$	2900
$\text{La}_2\text{O}_3+14\text{B}=2\text{LaBe}+\text{B}_2\text{O}_3$	1300
$2\text{Ti}+\text{C}_2\text{H}_2=2\text{TiC}+\text{H}_2$	3260
$2\text{Ta}+\text{C}_2\text{H}_2=2\text{TaC}+\text{H}_2$	3390

A comparison of the calculated temperatures with experimentally measured for some systems is given in Table 6. As can be seen from this table, the coincidence is very good in those cases when there is no significant effect on the temperature of any unrecorded phase transition (melting, dissociation, etc.). Thus, the analysis of adiabatic temperatures of the formation of various compounds leads us to the idea that the possibility of realizing the SHS process is not an exotic exception, but a rule for very many refractory compounds. Almost every refractory compound of metal and non-metal, stable at high temperatures, is formed from elements with strong heat release, and, consequently, can be obtained with the help of SHS.

Table 6 Comparison of calculated (adiabatic) and experimentally measured combustion temperatures for some SHS systems

Combustion reaction (SHS)	Calculated T _{ad} , K	Measured T _{ad} , K
$\text{Ni}+\text{Al}=\text{NiAl}$	1 910	1 910
$\text{Co}+\text{Al}=\text{CoAl}$	1 900	1 880
$\text{Ti}+\text{Si}=\text{TiSi}$	2 000	1 850
$\text{Ti}+2\text{Si}=\text{TiSi}_2$	1 800	1 770
$\text{Nb}+2\text{Si}=\text{NbSi}_2$	1 900	1 880
$\text{Mo}+2\text{Si}=\text{MoSi}_2$	1 900	1 920
$5\text{Ti}+3\text{Si}=\text{Ti}_5\text{Si}_3$	2 500	2 350

$\text{Nb}+\text{C}=\text{NbC}$	2 800	2 650
$2\text{Ta}+\text{C}=\text{Ta}_2\text{C}$	2 600	2 550

4. Experimental methods for studying SHS processes

The first experiments in the field of SHS were carried out on an installation called a constant pressure bomb. Many of these installations in modified form are used today. In Fig. 18 shows a diagram of a constant pressure bomb. The basic idea of this device is that, in view of the very large difference in volume between the chamber and the sample, the gas pressure does not change with combustion. The chamber is designed for a pressure of up to 250 atm, but can also hold a vacuum of the order of 10^{-3} Torr. Optical portholes serve for photographic registration of burning speed, pyrometry, spectral measurements.

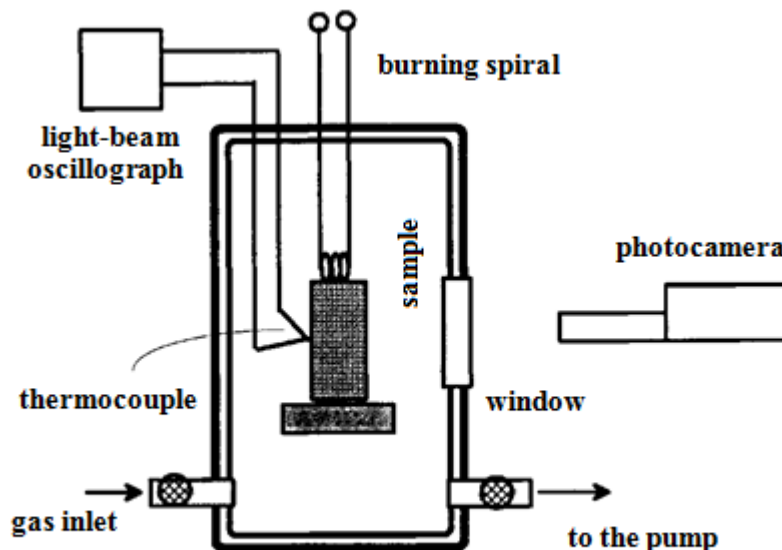

Fig. 18. Scheme of a reaction chamber for the laboratory study of SHS processes

Installation is produced in small series for research laboratories. It can produce combustion samples up to several tens of grams. Comparatively powerful current leads allow not only to make measurements inside the bomb (for example, thermocouple), but also to heat the samples with the help of resistance furnaces.

Almost all investigations of the macroscopic characteristics of combustion were carried out in installations of a similar type or analogous to them. This, above

all, the dependence of the average burning rate and the maximum combustion temperature on various parameters. In Fig. 19 shows the generalized dependences of the combustion rate obtained from the analysis of a large number of experimental studies on SHS (A.G. Merzhanov, 1986). It is interesting that the above dependences qualitatively coincide for various SHS systems, being, as it were, a visiting card of this process.

The most common method for measuring the maximum combustion temperature at the present time is thermocouple. Tungsten-rhenium thermocouples (BP5 / BP20) with a diameter of 100-200 microns are used. In Table 6 some results of thermocouple measurements were given, in comparison with the calculated combustion temperatures. As studies of the stability of uninsulated tungsten-rhenium thermocouples have shown, they have a high stability up to 2 600-2 800 K for a short time (up to 15 s). Repeated measurements of the combustion temperature not exceeding 2 800 K, with the same thermocouple, give a divergence of 30-40 K, which is quite acceptable. At the same time, metallographic studies of the thermocouples used showed that there is no noticeable interaction of the thermocouple material with combustion products. However, in the case of higher-temperature systems such as Ti-C, Zr-C, Ti-B, Hf-C, the destruction of thermocouples is apparently associated with the interaction of the thermocouple material with metal melts or carbon in the reaction zone. Therefore, in high-temperature systems with intense melting, only a single use of the thermocouple is possible, and the measurement error is estimated at 100-200 K, if the measurement is possible at all.

In the high-temperature region, optical methods are used: measurement of luminance or color temperature. Optical pyrometry is more convenient in comparison with thermocouple measurements, but it is more sinister than it is: firstly, they are related to the lack of accurate data on the emissivity of SHS systems, and, secondly, to the difference in the temperature of the radiating surface and temperature in the region of the sample.

In recent years, there has been an increase in interest in processes occurring at the microscopic level in the combustion wave. If the above methods allow us to determine the average velocity and the maximum combustion temperature, now we turn to the methods of determining the local velocity and temperature. The local speed of burning can be determined with the help of micro-video shooting. When examining the combustion wave, even with a small increase, it can be seen that the SHS front almost never represents an ideal flatness. The surface of the front is curved, it is possible to distinguish individual hot foci. If we select an arbitrary

point on the front and measure the velocity of this point at different instants of time, it turns out that this local instantaneous velocity makes very strong oscillations with respect to the average burning rate. Obviously, the micronality of the SHS wave is associated with the microstructure of the heterogeneous medium over which the wave propagates.

To measure the temperature distribution in different zones of the SHS wave, a microthermal technique is used. The temperature profiles obtained by this method have already been considered previously (Figure 3, 24). As for the microthermal technique itself, developed under the guidance of Professor A.A. Zenin, then, despite the seeming simplicity, it requires the experimenter of the highest skill. First of all, it is necessary to make a tungsten-rhenium thermocouple 5-7 microns in thickness. For this, there is a special method of welding and rolling. To avoid the interaction of the thermocouple with the surrounding reagents, it is covered with a thin layer of boron nitride, and only then it is pressed into the sample, as shown in Fig. 30. The processing of the results is carried out using the computer system "IKAROS", developed for this technique.

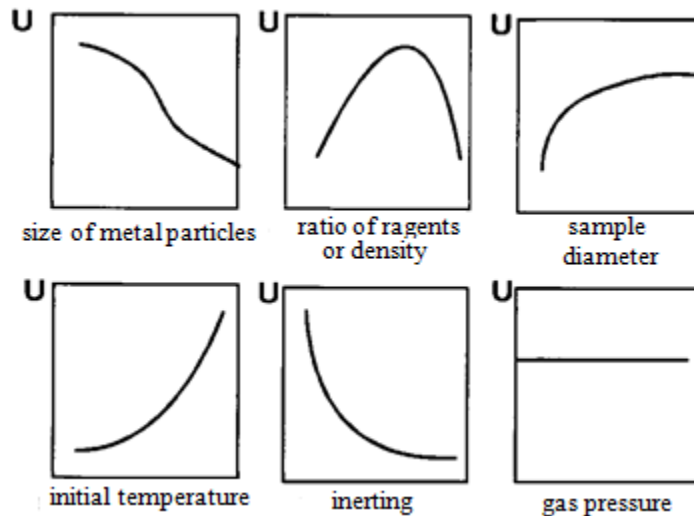

Fig. 19. Schematic dependences of the burning rate on the experimental parameters

Measurements of the temperature and the burning rate give, albeit important, but indirect information about the kinetics of the transformation in the SHS wave. An important stage in the development of experimental studies of SHS processes has been the development of techniques that allow us to follow the processes of phase formation and structure formation in a combustion wave.

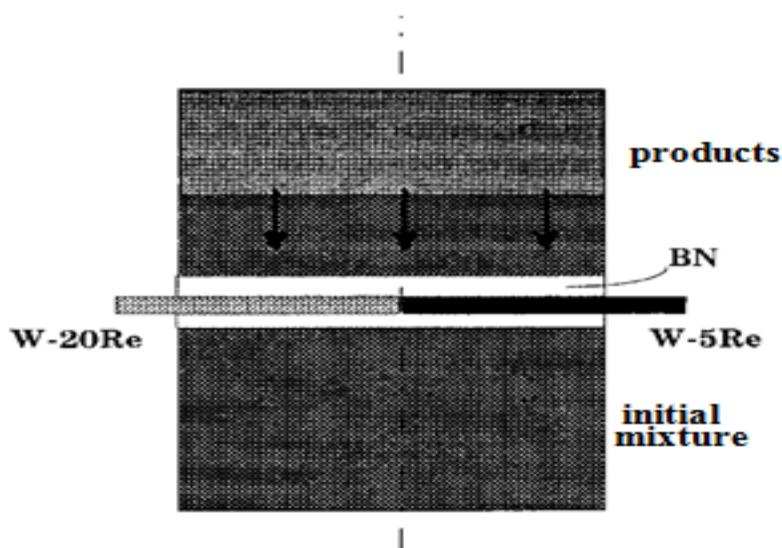

Fig. 20. Method of microthermocouple temperature measurement (thermocouple thickness 7-10 microns) (A.A. Zenin)

Here, first of all, we should dwell on the use of dynamic X-ray phase analysis on a diffractometer for synchronous radiation. Scheme of these experiments, first implemented by V.V. Aleksandrov and his colleagues in Novosibirsk are shown in Fig. 21. The source of synchronous radiation was the electron accumulator of the Institute of Nuclear Physics of the Siberian Branch of the USSR Academy of Sciences. The high power of the radiation made it possible to shorten the time of dialing the x-ray genogram to 0.5-1.0 s, which makes it possible to follow the dynamics of phase formation in the afterburning zone. For time-lapse X-ray photography, the authors used a one-dimensional detector with the recording of information on a computer. The gap between frames was 0.3 seconds.

Samples with a rectangular shape (19x15x70) were placed on a platform fixed to the goniometer stand and ignited. The surface of the sample, from which the radiographs were taken, was blown with helium. When the combustion front approached the point of incidence of the beam (sec. 1×10 mm), a synchrotron radiation gate was turned on, and the sequence of diffractograms, reflecting the dynamics of the measurement of the phase composition, was reduced: a kind of "X-ray phase film". In concluding the discussion of this technique, it should be noted that it is at present the only possibility of determining the phase composition and the crystal structure directly in the combustion wave. And despite this, this technique has not received widespread adoption. The reasons are obvious: not every laboratory and every institution has a synchrotron with an electron storage ring.

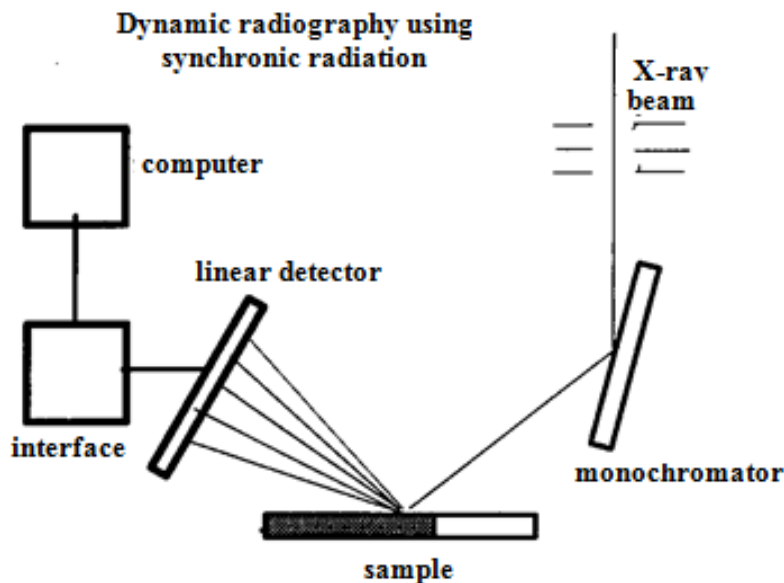

Fig. 21. Diagram of installation for dynamic radiography

Therefore, a fundamentally important development of this method was the creation of a laboratory installation for dynamic X-ray phase analysis based on a standard X-ray tube. This work was carried out in the laboratory of VI Ponomarev at the Institute of Structural Macrokinetics and Problems of Materials Science of the Russian Academy of Sciences (Chernogolovka), together with the Institute for Nuclear Research (Dubna). Thus, now it is possible to follow changes in the phase composition and crystal structure of the reaction medium directly in the SHS process.

No less interesting than the formation of the crystalline structure of the phases is the question of the formation of the microstructure of products and materials in the SHS wave. The microstructure is formed as a result of the destruction of the structural components of the initial reaction mixture, the nucleation and growth of grain (s) of the products, recrystallization, sintering, and other processes. To study microstructural transformations using optical and electronic metallography, microprobe analysis, it is necessary to "harden" the combustion wave in such a way as to fix intermediate microstructures in different zones of the wave. It is clear that it is practically impossible to "freeze" all the structural components present in the reaction zone and afterburning. For example, it is impossible to avoid the crystallization of metallic melts upon cooling, since very high cooling rates are required to produce amorphous metals - more than 10^6 K / s. Nevertheless, the existing methods of hardening SHS processes make it possible to obtain a fairly

reliable picture of microstructural transformations in the SHS wave. Let's consider some of these methods.

The first method of hardening the SHS wave was to immerse the burning sample in liquid argon. After the burning sample falls into liquid argon, the combustion process dies out, the front "stops" as it were, without reaching the end of the sample. However, as the experiments of A.S. Mukasian and co-authors, the rate of cooling in liquid argon is low ($\sim 10^2$ K/s). The reason for this is that a layer of gaseous argon with low thermal conductivity is formed around the heated sample after its immersion in liquid argon. Therefore quenching in liquefied gases or other liquids (for example, in water) allows us to stop relatively slow processes of structure formation.

The cooling rate is much higher when using a contact with a cold metal wall. In Fig. 22 shows a variant of such a hardening method, which has found wide application: quenching in a wedge-shaped cutout of a massive copper block. The reaction mixture is ignited at the wide edge of this wedge, and as the combustion proceeds, the specific heat losses increase, eventually leading to extinction. Thus, it is possible to achieve quenching rates up to several thousand degrees per second, the quench time in this case is tenths of a second. Such parameters make it possible in principle to "freeze" the processes of structure formation even at the initial stages with minimal distortions of the intermediate microstructures. A significant part of the experimental data on the formation of a microstructure was obtained by this method. Its advantages include also the relative simplicity and cheapness of the technique, the ability to regulate the level of heat loss by changing the angle of the wedge solution or the density of the reaction mixture.

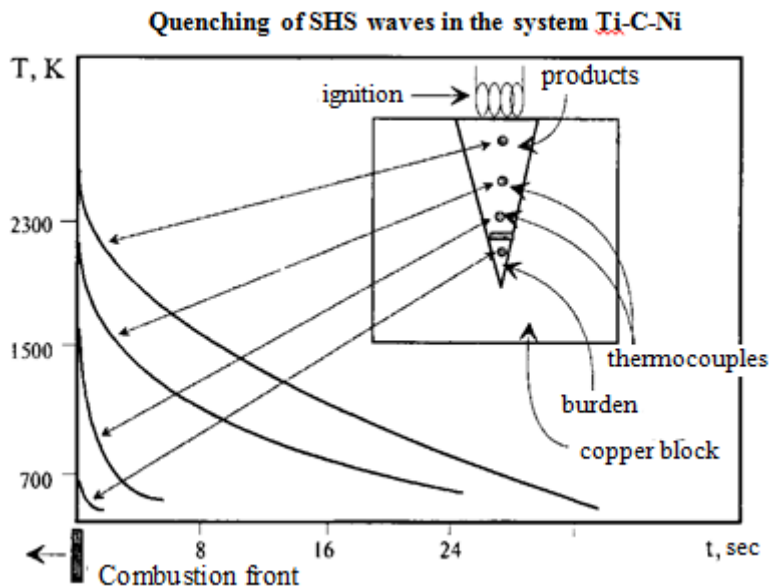

Fig. 22. The scheme of quenching of the SHS wave in a copper block and the cooling curves

The development of new methods of quenching continues to increase the rate of cooling. It should be noted here the methods of quenching using shock waves, developed by Yu.A. Gordopolov with co-authors. A metal capsule with SHS-charge is placed in a cylindrical channel inside the explosive charge. Detonation of the explosive leads to collapse of the metal shell and a sharp condensation of the reacting medium. It is interesting that, choosing the parameters of a shock wave, one can achieve both freezing and acceleration of the process of chemical interaction and structure formation. The improvement of this methodology continues.

In the Byelorussian Institute of Heat and Mass Transfer, on the basis of theoretical calculations, they came to the conclusion that the use of a liquid cooling agent can still give the fastest rate of charging. To avoid the formation of a heat-insulating gas layer, it is suggested to direct a strong jet of liquid onto the burning bundle, as shown in Fig. 23

. The velocity of the jet must be large enough to "blow off" the gas layer and ensure direct contact of the liquid flow with the sample. In the Institute experiments were conducted with water jets, the speed of which reaches 150 meters per second, that is, 540 km / h. At the same time, the tempo of quenching on a Ti + C sample of $1.6 \cdot 10^4$ K / s (16 kilocalories per second) was reached.

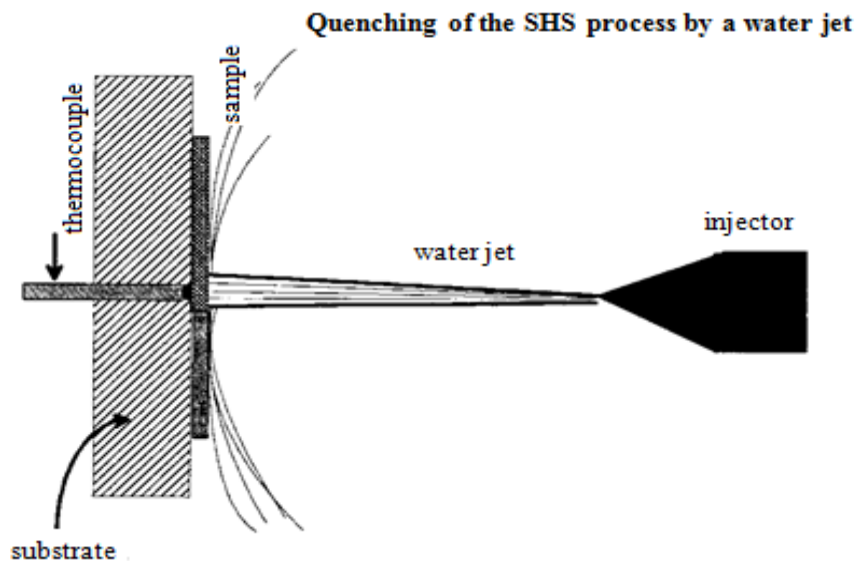

Fig.

23 Fig. 2

Fig. 23 - Scheme for quenching a SHS wave by a water jet

Another important area of SHS research is related to the experimental modeling of both macroscopic and micro-scopic processes occurring in the SHS wave. With some of these methods we have already encountered, for example, the technique of electro-thermal explosion (V.A. Kniazik, A.S. Steinberg). The sample is heated by an electric current with velocities comparable to the heating rate in the combustion wave. The temperature is fixed by a photodetachter. When a reaction begins in the sample, the heat of chemical heat release is added to the electrical power, which is manifested in a break in the experimental curve. Computer processing of these data allows us to judge the kinetics of the interaction in a combustion wave.

In the electrothermographic method, the heating is subjected to a thin metal filament rather than to a mixture. Using this technique, developed under the guidance of Professor Yu.M. Grigor'ev, we can follow the kinetics of chemical transformation by changing the electric resistance of the filament, caused by the growth of the layers of the product. Quenching of yarns and their metallographic research also allow studying the processes of formation of the microstructure of products. The electrothermograph allows to work both in constant temperature mode (thanks to feedback and photosensor), and in the regime of constant power of heat release. This technique is most applicable to solid-gas systems, when one of the reagents is solid, and the other is gaseous. The use of the electrothermograph technique made it possible to obtain a number of interesting results on the interaction of transition metals with nitrogen, hydrogen, and hydrocarbons.

A further development of these methods was the method of experimental modeling of the interaction processes of microscopic particles, including heterogeneous systems with intense melting. In Fig. 24 shows the scheme of this technique using the niobium-boron system as an example. The boron particles are placed on the surface of the niobium foil, which is heated by an electric current at a rate equal to the rate of increase in temperature in the combustion wave. The small thickness of the foil makes it possible to cool it very quickly at various stages of interaction in order to study the microstructure of the products at the stage of their formation.

The interaction of a particle with a substrate as a method for modeling SHS processes was also developed in Novosibirsk (V.V. Aleksandrov and co-authors). The peculiarity of this method is that the particle is heated by an electron beam

(Figure 35), and the same beam is used to obtain the image, since the whole process occurs in the electron microscope chamber.

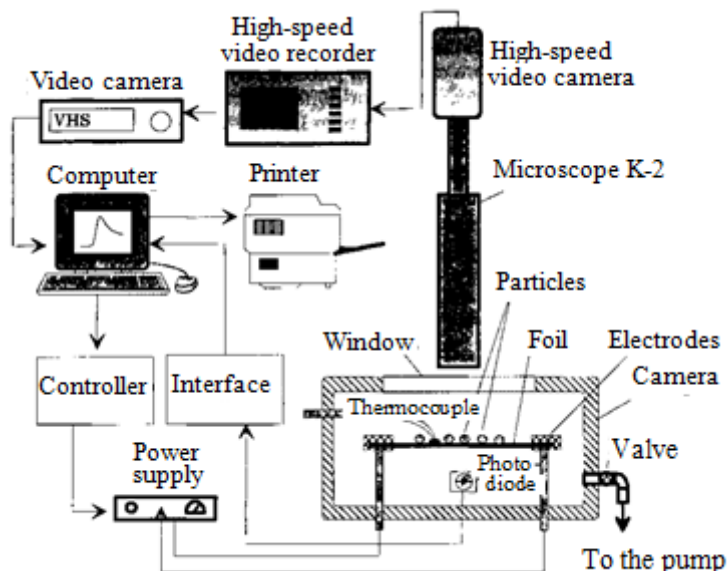

Fig. 24. Scheme of installation for experimental modeling of the reaction cell (experiments "particle-foil")

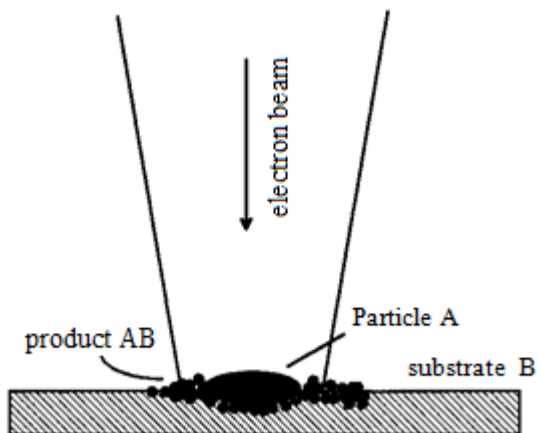

Fig. 25. Scheme of a model experiment with heating a particle on a substrate by an electron beam

In recent years, interest has increased in the study of gas evolution in SHS and the composition of gases formed during combustion. The diagram of the apparatus for sampling gas samples is shown in Fig. 36. Continuous recording of pressure in

the combustion chamber made it possible to find an interesting effect: the gases released during combustion are relatively quickly absorbed by the synthesis product, and the absorption rate and the number of absorbed gases depend on the composition of the product. The composition of gas samples is investigated, as a rule, by means of mass spectrometers. As noted earlier, the main gas impurities are hydrogen and carbon monoxide. Directly during combustion it is possible to determine the composition of gases using spectral methods.

In conclusion, I must say that we have considered only original methods specially developed for the study of processes and products of SHS. However, for the same purposes, widely used chemical and physical methods of research, in which it is not worthwhile to specify in detail precisely because of their common knowledge. For example, many results were obtained with the help of optical and electron microscopy, microprobe X-ray analysis, differential thermal analysis and gravimetry, Auger spectroscopy, and other known methods. At the same time, the range of research methods is constantly expanding, including both new known methods (for example, a tunnel and atomic force microscope), and original techniques developed specifically for SHS research.

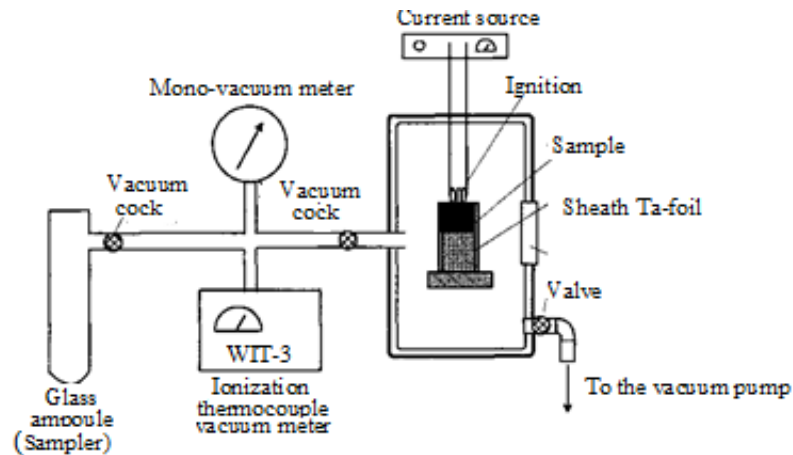

Fig. 26. Scheme of the installation for the investigation of impurity gas evolution in SHS

5 Structural formation of SHS products

When considering the methods of experimental research of SHS processes in the previous lecture, one could notice that many of them are aimed at studying the structure of products. This is not accidental: the structure of the product determines its properties, especially if it is a structural or tool material. It can be said without

exaggeration that the task of managing the structure of the product is the most important for the further development of IFOR. In this case, the structure is understood as a wide range of characteristics, including:

- macrostructure (distribution of composition, macroscopic defects);
- microstructure (mutual arrangement of phases and crystallites, granular structure of products, localization of impurities, porosity);
- crystal structure (type and parameters of the crystal lattice, its defectiveness, ordering with the formation of superstructures, the number and distribution of dislocations).

To control the structure, it is necessary to have a deep knowledge of the laws and mechanisms of evolution of the structure in the combustion wave at all structural levels: macrostructure, microstructure, atomic-crystal structure. Awareness of this need and led in the early 80's to the emergence of a new scientific trend, known as "structural macrokinetics." For the first time this term was used by A.G. Merzhanov in his plenary report "Macroscopic kinetics and its role in modern chemistry," at the 1st All-Union Symposium on Macrokinetics and Physical Gas Dynamics in 1984. Структурная макрокинетика изучает эволюцию структуры среды в ходе химических превращений с учетом процессов тепло- и массообмена. Для наглядности можно привести следующие формулы, определяющие структурную макрокинетику и ее взаимосвязи с классической макрокинетикой:

Classical = chemical + theory of heat
macrokinetics kinetics and mass transfer

Structural = classical + kinetics of structural
Macrokinetics macrokinetics transformations

Structural macrokinetics is now at the beginning of its development, it still has to create its own scientific apparatus, to generalize the accumulated experimental facts. Today, the greatest information is available for the connection between the structural characteristics of the SHS products with the parameters of charge and combustion conditions. A large amount of empirical material is collected, which does not pretend to decipher the mechanism and dynamics of structure formation.

This approach, sometimes called "structural statics", is essentially the applied material science of SHS products. The second approach, called "structural dynamics," is aimed at studying the evolution of the structural environment in the SHS wave. For this, both the quenching of combustion processes and intermediate products, as well as the direct measurements during combustion, are used.

The formation of a microstructure is most studied for two-component mixtures of metals and nonmetals. As shown by studies of quenched Ti + C samples, the first signs of product formation can be registered where a metallic melt appeared. This melt very quickly spreads over the carbon surface in the form of a thin film (if the surface is sufficiently extended, that is, the particles of the carbon material are large enough). The structure of this film is quite remarkable, it is shown schematically in Fig. 27a. At the boundary of the melt with carbon (graphite), a layer of carbide crystals is formed. The thickness of this layer corresponds approximately to the size of one crystal and usually does not exceed 1 μm . At the same time, the extent of the layer over the surface can be thousands of times greater than its thickness, if the interface surface is large enough. Reaction of carbide formation proceeds at the periphery of the spreading layer, so that direct contact of the melt with carbon is realized only in this region. A very rapid quenching (-10^3 - 10^4 K/s) makes it possible to observe the propagation of this layer over the particles of the carbon reagent in the SHS mixture. One such microstructure is shown in Fig. 27b. Here, grains of titanium carbide are visible, forming a monolayer on the surface of the graphite particle. (The layer of metallic titanium is dissolved by acid for clarity.)

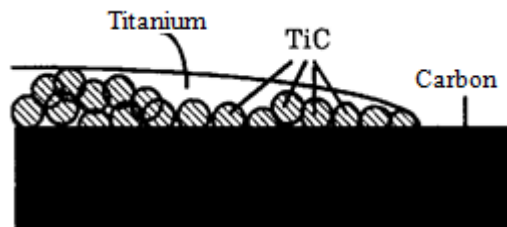

Fig. 27a. Scheme of propagation of a carbide layer in the interaction of a molten titanium particle with a carbon substrate



Fig. 27b. Microstructure of the formed layer

It is interesting that the dimensions of carbide grains (crystals) are distributed in a relatively narrow interval, as shown in Fig. 28. The presented microstructure is the primary structure of the SHS product. The fact that the size of the primary carbide grains is not directly related to the size of the particles, the initial reagents, is of fundamental importance for the choice of ways to manage structure formation. For example, if during sintering the structure of a material depends very strongly on the dispersion of the initial powders, then in the SHS the structure of the final product is determined by the parameters of the combustion and afterburning zone: temperature, duration of afterburning, cooling rate, etc. The grain or crystal size of the final product can be as much more, and much less than the size of the particles of the reagents (metals, carbon, etc.).

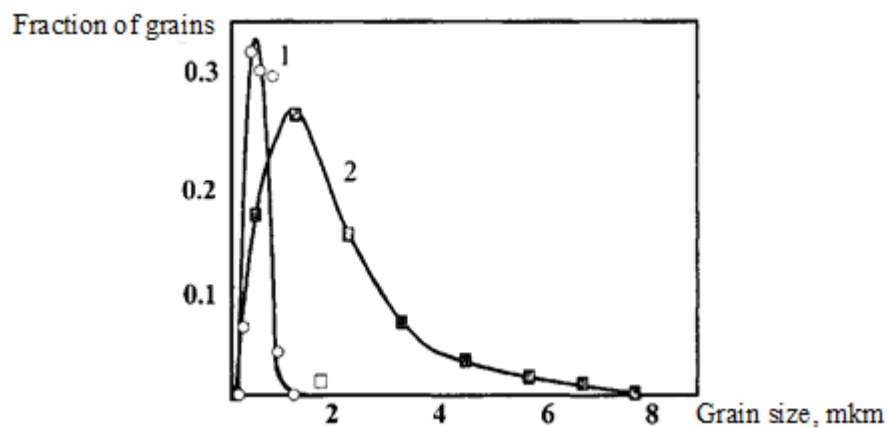

Fig. 28. Distribution of primary titanium carbide grain sizes 1 - quenched combustion front, 2 - model particle-foil experiment

The formation of a layer of primary crystals can be most clearly seen in the case of an unlimitedly large extent of the carbon surface, for example, in the case when a titanium particle spreads over a heated graphite plate. The structures that appear in this case are shown in Fig. 29.

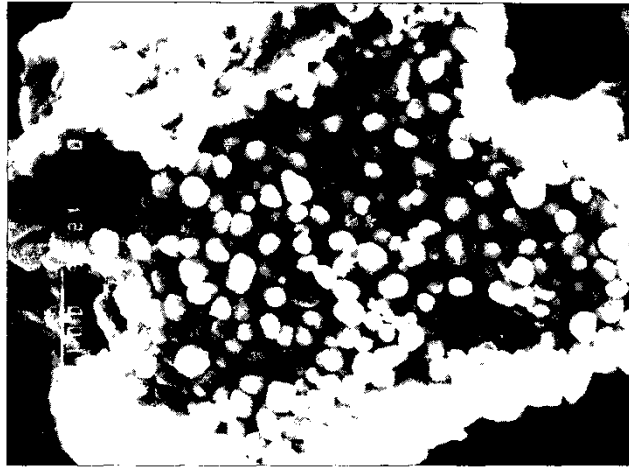

Fig. 29. Microstructure of primary grains of titanium carbide

The further development of the microstructure of the products depends on the size of the particles of the carbon component, the amount of melt and the temperature. Currently, there are four possible "scenarios" of structure formation. If the dimensions of the carbon particles are of the order of $10^3\mu\text{m}$ or more, then after saturation of the melt with carbon, a layer of carbide at the interface separates. This layer has a polycrystalline structure and grows according to a parabolic law. Such a microstructure was observed in experiments on the interaction of carbon with decompositions (melting of metals in graphite crucibles), so we should not dwell on it in detail. Interesting features of the structure formation, characteristic for SHS, begin to appear when the particle size of the carbon component is several micrometers, that is, when the diameter of the carbon particles becomes comparable with the size of the carbide crystals in the primary layer. The carbide crystals separate from the carbon surface and pass into the melt under the action of wetting forces and crystallization pressure. After all the carbon has reacted, a dispersion of fine carbide crystals is formed, separated by melt layers. This structure is realized on the boundary of the call of combustion and afterburning and serves as a starting point for the recrystallization processes, which already form the

structure of the cobalt product. The third "scenario" of the primary structure formation is realized with the sizes of carbon particles smaller than 1 μm . In this case, the primary carbide crystals grow in the volume of the melt, and particles of the carbon component serving as a source of carbon are also present in the same melt. After complete dissolution of carbon, a primary microstructure is formed, shown in Fig. 29. The size of carbide crystals is 1-2 μm .

Finally, the fourth "scenario" of the primary structure formation is reduced to the complete dissolution of carbon in the melt without the formation of a solid product. In this case, the formation of the structure begins after cooling the melt (in the zone of structure formation), when the temperature of the product falls below the liquidus curve.

Thus, the primary structure formed in the reaction zone can be either a melt or a dispersion of submicron and micron grains in the melt. In Fig. Figure 40 shows the approximate kinetics of the growth of carbide grains in the zone of secondary structure formation of the SHS wave. The linear growth rate of the average grain diameter is estimated to be 1-30 $\mu\text{m} / \text{s}$. The increase in the average size is due to the dissolution of small crystals and the growth due to this large (Ostwald ripening).

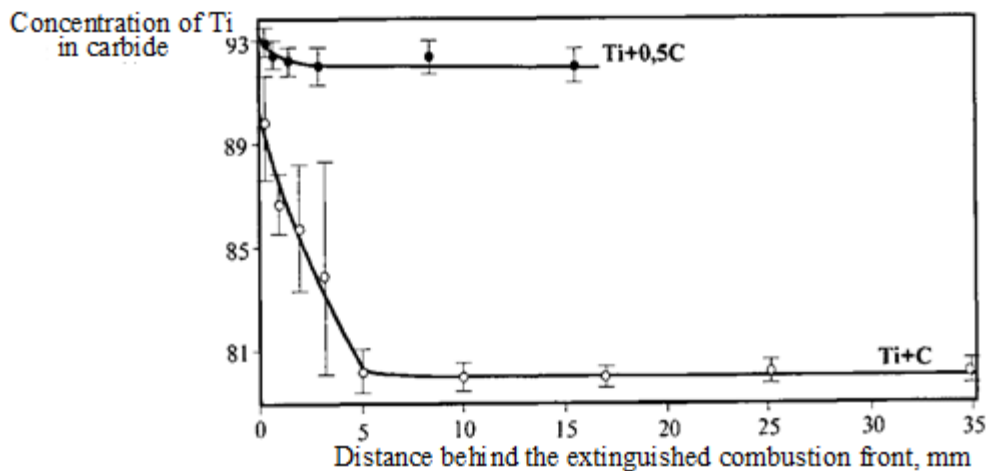
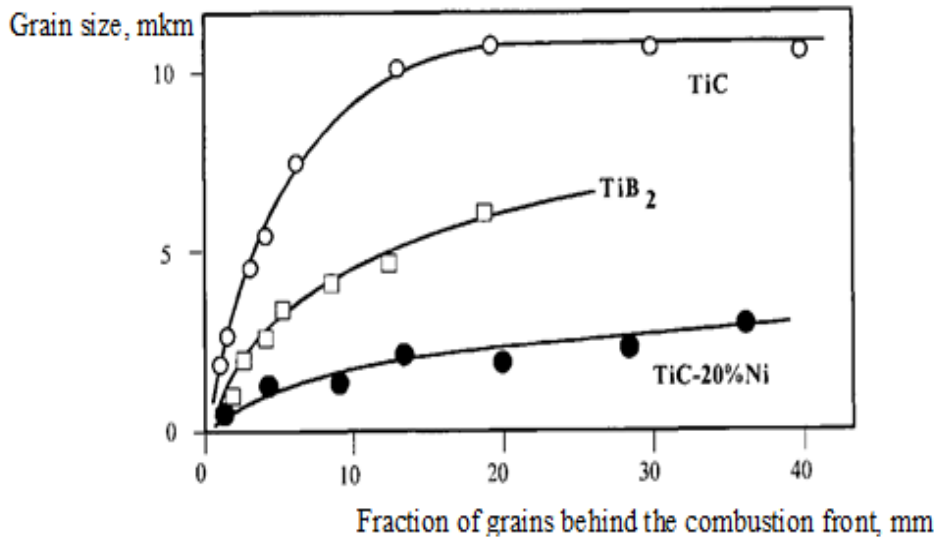

Fig. 30. Dependence of the size and composition of product grains on the distance behind the combustion front

It also shows the change in the composition of carbide grains. The results of microanalysis of individual grains lie inside the shaded "corridor". Throughout the width of the zone of structure formation, the carbide composition is closer to stoichiometry than it would be when crystallized from the melt. The structure of the final product is shown in Fig. 31. Carbide grains have a rounded shape, characteristic for crystal growth in the melt. If the fraction of the melt is small, the carbide grains have the form of irregular polygons: the flat faces correspond to the boundaries between the grains, and the free surface has a rounded shape.

Structuration in metal-boron systems is in many ways analogous to structure formation in metal-carbon systems. The difference lies in the fact that both reagents can melt in these systems in the combustion wave. Therefore, depending on the ratio of the melting points, either the metal spreads over the solid boron (a system of the Ti-B type), or the molten boron spreads over the surface of the metal.

For example, in Fig. 32a shows the spreading of a boron particle over the niobium surface. As X-ray phase and X-ray microprobe analysis showed, a layer of higher boride NbB_2 forms immediately upon spreading. If we consider the resulting "spots" of the product with a large increase, it turns out that they consist of small rounded grains very similar to grains, which we saw in the layer of titanium carbide (Fig. 426). It can be seen that the periphery of the grain is smaller than in the center. The distribution of the average grain size by the diameter of the primary product layer is shown in Fig. 43: as we see, the growth of grains occurs over a distance of $-10 \mu\text{m}$ from the edge of the spot, while in the central region the crystal size is practically constant. A similar process—the propagation of a thin layer of boron along the surface of niobium and the simultaneous formation of diboride—occurs also in a mixture of niobium and boron powders at SHS. In this case, a thin layer of product is formed on the surface of the niobium particle.

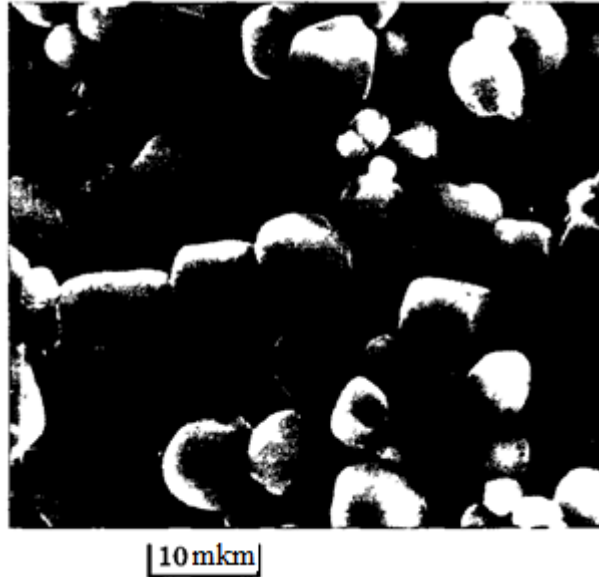

Fig. 31. Titanium carbide grains after secondary structure formation

The primary product formed in the reaction zone (on the border with the afterburning zone) in metal-boron systems is characterized by a grain size of 1-2 μm , regardless of the size of the initial reagents. A typical microstructure of the primary SHS product is shown in Fig. 32, at an example of the titanium-boron system. The kinetics of grain growth behind the combustion front (in the afterburning zone), studied by quenching methods, is shown in Fig. 42. Let us pay attention to the constancy of the parameters of the crystal lattice of diboride throughout the burnout zone.

Finally, we turn to the metal-gas system, for example, to the titanium-nitrogen system. In the work of S. Divi and Z.A. Munir proposed and justified the model according to which the propagation of the SHS wave occurs as a result of the formation of a thin layer of titanium nitride TiN on the surface of a metal particle. This primary layer can then dissolve in the metal phase, forming a solid solution, and after supersaturation of the solution - precipitating in the form of nitride grains in the bulk of the metal.

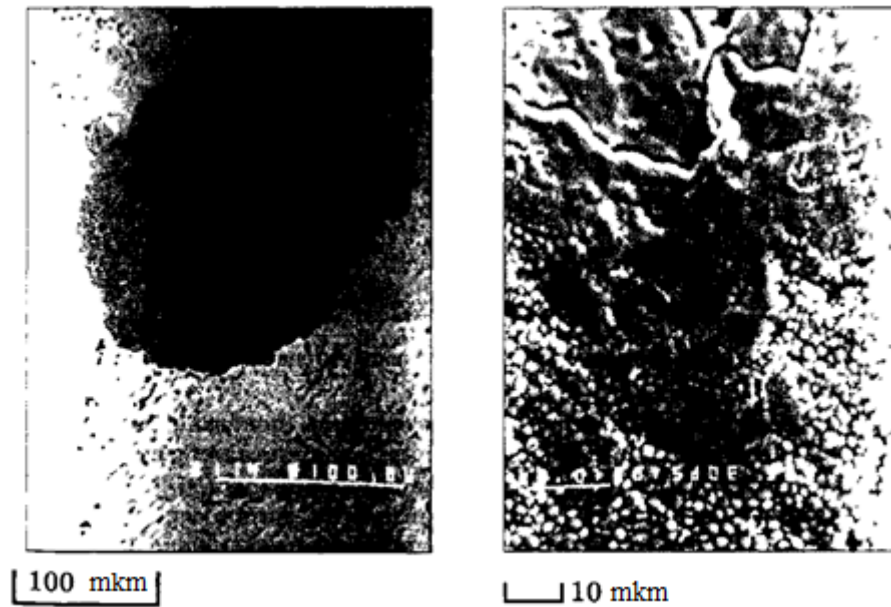

Fig. 32. Interaction of a boron particle with a substrate (niobium): a. spot product (in the center - unreacted boron particle), b. microstructure of the NbB_2 product layer

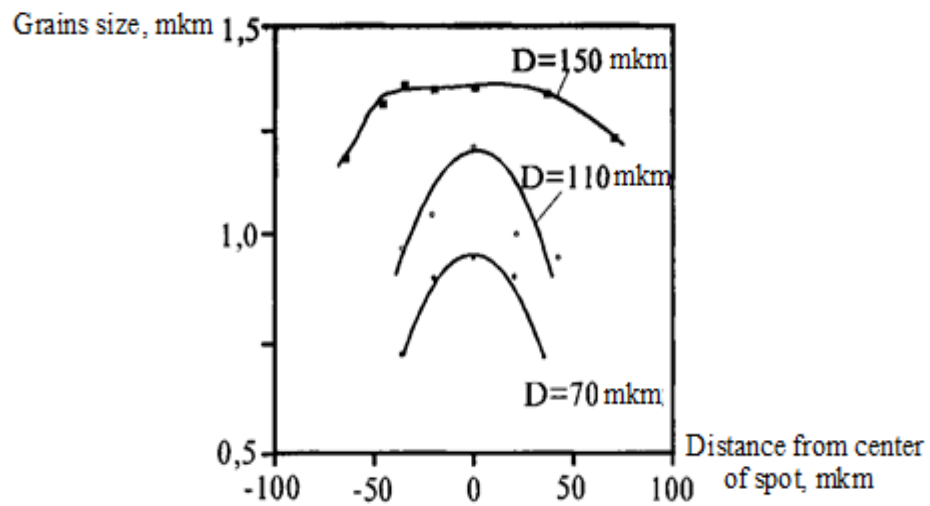

Fig. 33. Distribution of grain sizes of NbB_2 by the diameter of the product spot

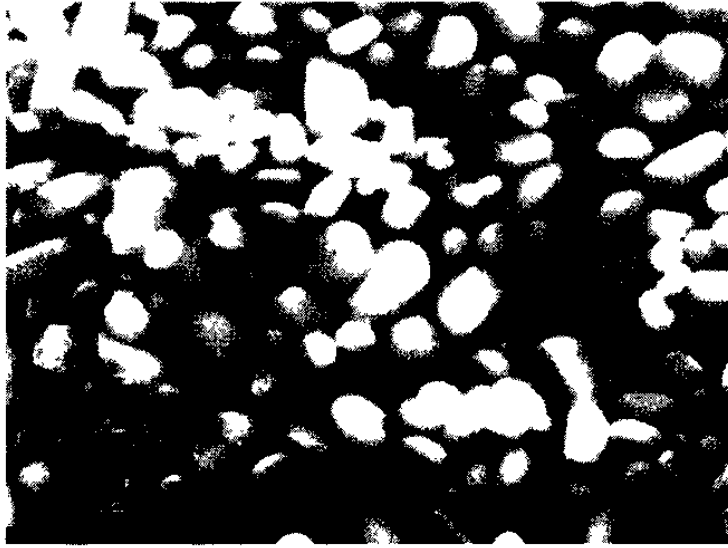

Fig. 34. Microstructure of primary grains of titanium diboride

With further interaction, a thick layer of titanium nitride forms, which grows as the reaction proceeds. In the works of A. Mukasyan and co-authors, the possibility of propagating the SHS wave in the Ti-N system due to the formation of a thin (1-2 μm thick) layer of nitride on the surface of metallic particles was confirmed, and the microstructure of this layer was investigated. It turned out that it consists of rounded nitride grains and is very similar in structure to the carbide and boride layers that we have already examined.

Thus, the formation of the product microstructure in SHS systems includes three stages:

- formation of a thin ($\leq 1 \mu\text{m}$) layer of product crystals on the surface of the particles of the reagents;
- formation of small primary crystals (1-2 μm) throughout the volume of the reaction medium (reaction zone);
- crystal growth due to recrystallization (Ostwald co-generation) and coalescence.

The similarity of the mechanisms of structure formation in SHS systems with intensive melting of reagents leads to a similarity of the microstructures of the final product. Of course, the widespread patterns of structure formation do not describe the entire variety of SHS products. In systems without intense melting, completely different microstructures can be formed, for example, in Ta-C, Mo-B systems. Another mechanism of structure formation is observed in systems with a reducing

stage in hydride, intermetallic and other systems. However, since the purpose of this training manual is only the most general acquaintance with IFOR, we have considered only some of the most studied results.

6 Technological fundamentals of SHS processes

At present, IFOR has been formed as a major technological direction, capable of solving a set of tasks for obtaining:

- chemical products of specified composition;
- materials of a given structure;
- Parts of a certain shape and size, including those with coatings;
- products with the required level of performance.

Today we can distinguish 6 different technological types of self-propagating high-temperature synthesis:

1. SHS-technology of blanks and powders;
2. SHS-sintering;
3. Force SHS compaction;
4. SHS-metallurgy;
5. SHS-welding;
6. technology of gas-transported SHS-coatings.

Consider all 6 technological types of SHS.

6.1 SHS-technology of powders

The technology is based on the combustion of charge in special reactors with a capacity of up to 30 liters. The SHS product obtained under such conditions is a formless mass-a speck or ingot of practical importance. For example, nitrated ligatures obtained by burning ferroalloys in nitrogen are used to introduce nitrogen into steel. Synthesis of charge briquettes that have undergone thermovacuum processing in a vacuum leads to the production of porous preforms with the size and shape of these briquettes. This technological method allows to obtain a wide range of simple and complex porous products, including filters, pistons, friction pairs of electrocontacts, catalysts from intermetallic compounds. The material of the porous product is selected based on the specific requirements for its operation.

By varying the combustion conditions with the help of various physico-chemical and technological parameters, it is possible to solve problems of regulating the structure and properties of powders.

According to this technology, the Institute of Structural Macrokinetics and Material Science Problems of the Russian Academy of Sciences has established the

production of various powders: β - Si_3N_4 , α - Si_3N_4 , TiC, TiB_2 , TiN, TiC_xN_y , SiC, B_4C , AlN, SiAlO_xN_y and others.

Combustion products are usually porous sintered powders, which are subjected to subsequent mechanical or chemical-thermal processing to produce powders for various purposes.

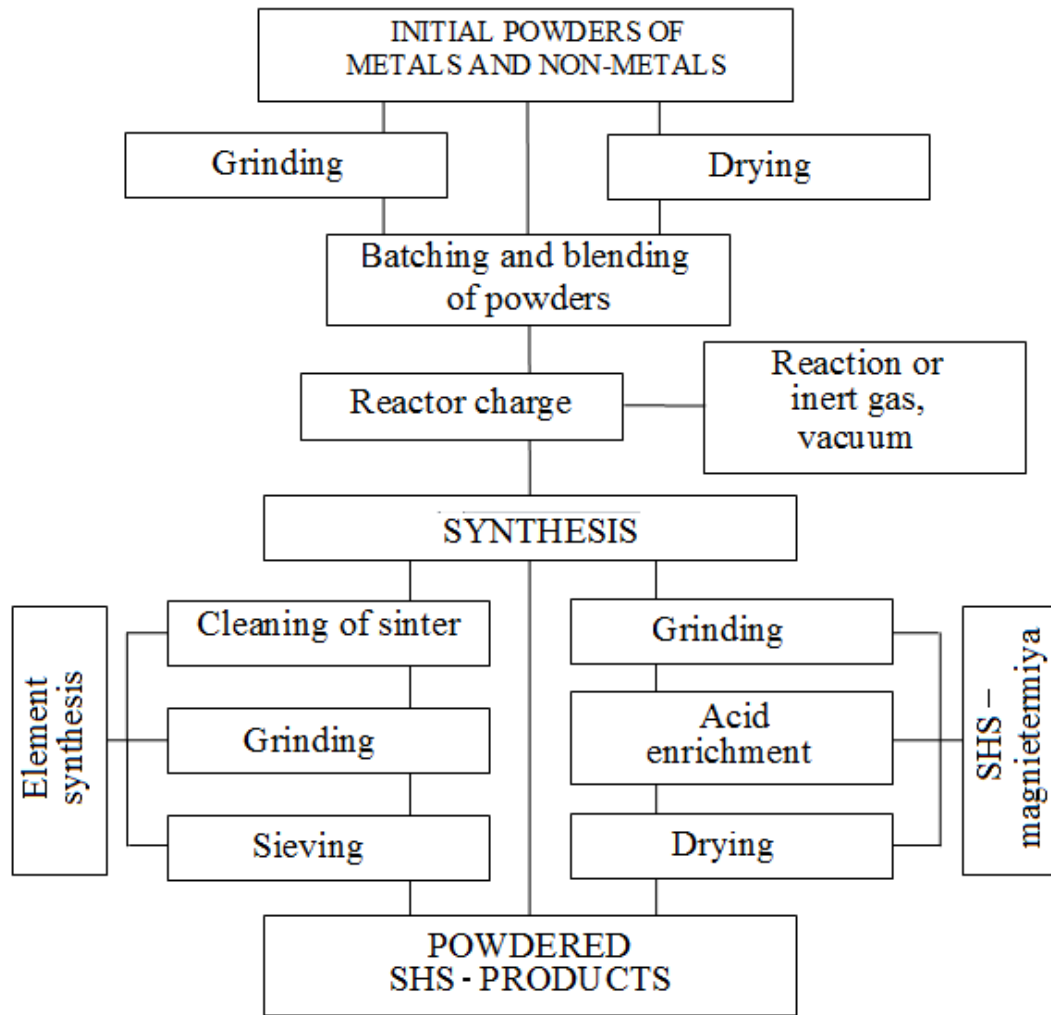

Fig. 35 Scheme of SHS-technology for the production of powders

The general scheme of SHS-technology for the production of powders is shown in Fig. 35. It includes the following operations:

- Preparation of charge: sieving, grinding, drying components, mixing;
- filling the reactor with charge and gases, or creating a vacuum in the reactor;
- synthesis after a short-term thermal initiation;

- the subsequent processing of products of synthesis, which depends on the type of synthesis: elemental or magnesium-thermal. In the case of elemental synthesis, the product undergoes only mechanical processing: stripping, grinding, and screening. In the case of SHS-magnesium-thermal, the synthesis product is ground and subjected to acidic enrichment to remove magnesium oxide from the product, and then drying.

The technology is based on the reaction $\text{Ti} + \text{C} \rightarrow \text{TiC}$ in the combustion of a mixture of titanium and carbon powders. According to this stoichiometric equation, the mixture of starting powders (batch) must consist of 80.0% by mass of titanium powder and 20.0% of carbon powder. The content of bound carbon in the stoichiometric product - titanium carbide - should be theoretically 20.0% by weight. After a real synthesis, the content of bound carbon is usually less than the theoretical content of $C_{\text{bound}} = 20.0\%$. In addition, in a real product, there is usually a certain amount of free, unreacted carbon, C_{free} . The sum of the contents of bound and free carbon gives the total carbon content in the product C_{total} . The closer the content of bound carbon in a real product to the theoretical 20.0% and the lower the content of free carbon in it, the better the product of synthesis, the better the synthesis itself. The quality of the product is also affected by the oxygen content in it: the less oxygen, the better the product of synthesis. Therefore, they try to reduce the oxygen content in the initial reagents and prevent the appearance of oxygen in the product during the synthesis, for which the synthesis is carried out either in an inert gas atmosphere or in a vacuum.

6.2. SHS-sintering

The goal is the realization of sintering both in the combustion wave and in the heated (still not cooled) combustion products. The initial mixture of powders for synthesis is molded into a shaped product. Combustion is organized in such a way that during the process the shape and dimensions of the workpiece are not distorted. The combustion product is a finished product with a porosity of typically 5-50%. But under special conditions, very small, almost zero porosity can be achieved, and vice versa - very large, up to 96%.

SHS-sintering is carried out in thermovacuum chambers, in the open air, and in special SHS gas-gas meters. This technology produces porous products, refractory materials and high-density ceramic products.

Most of the developments on SHS-sintering are performed in ISMAN.

One of the promising tasks is to organize the sintering of a solid product formed in the course of SHS in order to obtain products of a given shape and size.

Traditional methods of sintering ceramic products (hot pressing, gas-static hot pressing) are characterized by high material and energy costs.

Of great interest is the production of ceramic materials and products by direct synthesis of metal or non-metal with gas in the burning mode, bypassing the stage of preliminary preparation of ceramic powders and subsequent compaction to a given shape and size. Such an option is realized in special SHS gas-gas meters that allow the synthesis of final products and the simultaneous formation of products at pressures of the active gas up to 8,000 atm and temperatures of 1,000-3,000 ° C, developing due to the heat of the exothermic reaction.

The main technological parameters are the following: the pressure of the reagent gas; degree of dilution of the charge by final products. These parameters make it possible to provide a mode of layer-by-layer filtration combustion and the required porosity of the material. Porosity can vary within wide limits: 10 - 50%.

One of the first works, which initiated the technology of SHS-sintering, was the work of I.P. Borovinskaya on the synthesis of nitrides of transition metals and boron during the combustion of porous samples in gaseous nitrogen. Further detailed studies were made of the influence of high nitrogen pressures on the chemical, phase composition and structure of materials based on non-stoichiometric and near-stoichiometric titanium, zirconium and tantalum nitrides, and also developed a method for direct synthesis in SHS mode of products of specified composition and required form.

Examples of gas-static SHS-technology are the production of materials from anoxic ceramics based on silicon nitride- β - Si_3N_4 , high-temperature Si_3N_4 -SiC ceramics, the production of insulating sleeves from BN for directional crystallization furnaces, turbine blades from Si_3N_4 -TiN-TiC, metal wires from ceramics based on TiB_2 -AlN for casting steels and slags.

The technology of production of refractory SHS-materials and oxides belongs to the direction of SHS-sintering.

The choice of the composition of the initial charge is carried out on the basis of the requirements for refractories (refractoriness, heat resistance) and the requirements for sufficient exothermicity of the charge, a small shrinkage and a small mass loss during combustion. Refractory products are prepared from a mixture of the chromate of the alkaline earth metal (MgCrO_4 , CaCrO_4 , BaCrO_4), the metal-reducing agent (Al, Mg) and fire-oxide oxide (Al_2O_3 , MgO, CaO). The mixture is formed, placed in special forms and initiates a combustion reaction in air.

Thus, refractory bricks are obtained by a porosity of 30-40% and fire resistance up to 1,900 ° C. The achievement of this direction was the possibility of

applying refractory coatings on the surface of a complex profile, as well as the development of technologies for the production of porous plates from composite materials (by the reaction $\text{TiO}_2 + \text{B}_2\text{O}_3 + \text{ZnO}_2 + \text{Al}$) and complex oxides for electronic engineering - titanates, zirconates, niobates, ferrites, and so on.

The essence of the technology for the production of refractory protective coatings is to prepare the mixture, moisten it with a solution of a binder (usually water solutions of mineral salts are used), apply the moistened mass to the surface to be protected, dry and initiate the combustion process in the mixture. The selection of the binder determines the drying conditions, molding characteristics and properties (strength, porosity) of the final products.

6.3. Force SHS compaction. General characteristic of the technology

To obtain non-porous articles, a set of solutions was developed in which the SHS product heated by the combustion wave is subjected to compaction by pressure treatment. The analysis is based on the time diagram of the process:

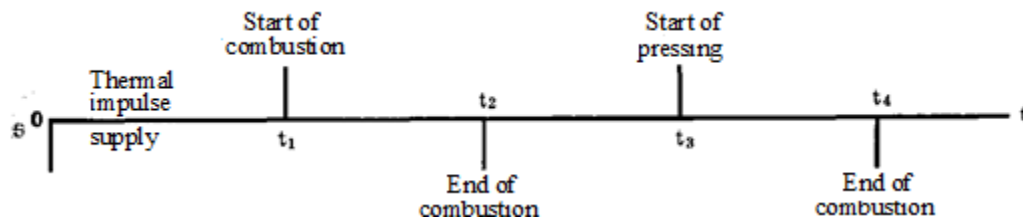

The condition of uniformity of the workpiece:

$$t_1 \ll t_2$$

$$t_2 - t_1 \ll t_p,$$

where t_p — the thermal relaxation time of the sample.

Conditions for obtaining materials and products with the lowest porosity while maintaining the shape and dimensions:

$$t_d = t_3 - t_2 = (t_{\text{opt}})_1 \text{ — time of pressing delay;}$$

$$t_p = t_4 - t_3 = (t_{\text{opt}})_2 \text{ — holding time under pressure;}$$

$$P = P_{\text{opt}},$$

"opt" — the optimal value.

The quantitative relationships of the characteristic times of SHS-compacting

are given in Table 10.

Table 10 Characteristics of the SHS compaction technology

Parameter	Time range, s
Initiation time (t_1)	0,3-0,7
Burning time ($t_2 - t_1$)	0,5-15,0
Pressing delay time ($t_3 - t_2$)	1-10
Time of pressing and aging under pressure ($t_4 - t_3$)	30-80
Mold release time	3-120
Total process time	35-225

The most important characteristic of the process for achieving minimal porosity is the delay time (t_d). The dependence of the residual porosity on t_d is clearly extreme. There is a curve with a minimum at some optimal value (t_{opt}) l. The increase in porosity at $t_d(t_{opt})$ l is related to the loss of plasticity of the product during its transition to an elastic state.

The search for optimal values of parameters - delay time, holding time and pressure - is a specific task of experimental research. Each of these parameters influences the structure and properties of a compact SHS material. The most severe effect on the hardness, strength of alloys is the delay time.

The method of self-propagating high-temperature synthesis-compaction is of great interest for the problem of creating unique materials, especially free-solid alloys with a metastable structure. A number of new compositions have been developed in a wide range of physic-mechanical properties. Self-propagating high-temperature synthesis - alloys have a high purity of impurities, a perfect monocrystallinity of granules. These alloys have received the name SHTM - synthetic hard tool materials.

The advantage of this method is the ease of carrying out the process. Schematic diagrams of the process of SHS-pressing are shown in Fig. 46. After application of external compression pressure to the combustion products, condensation occurs (shrinkage). The mechanism of compaction of products of

synthesis is determined in principle by the composition of the final products. Obviously, the greatest densification occurs in the case of pressing products containing a liquid melt of one of the components (ligaments), as can be seen from Fig. 36. The presence of a bundle greatly accelerates the sliding of carbide granules, and the liquid bond acts as a lubricant. If the synthesis product is in a solid aggregate state (as in the case of $Ta + C \rightarrow TaC$), the compaction is possible only by sliding the carbide granules and diffusing pore healing. Finally, when the product of the interaction of titanium and carbon ($Ti + C \rightarrow TiC$) is compacted, the compaction takes place in several stages: 1 - sliding of the granules; 2 - plastic deformation of granules; 3 - diffusion healing of pores.

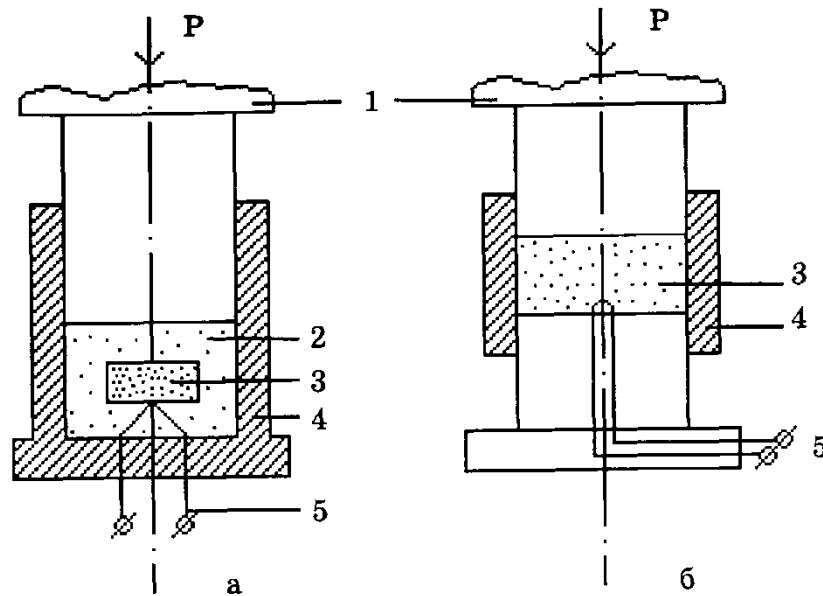

Fig. 36. Schematic diagrams of the process of SHS-pressing:
a - for thin workpieces; b-for large-sized workpieces.

1-punch; 2-heat insulator; 3-charge SHS; 4-press mold; 5-initiating device.

The technology of SHS-pressing is used to produce hard-alloy products - rolls, dies, press tools, cutting inserts, targets for magnetron and cathode sputtering, electrodes for electrospark doping, etc. To intensify the processes of SHS-compaction, an ultrasonic field is used. As shown in the works of E.A. Levashov et al., ultrasound intensifies all three stages of compaction: accelerates the sliding of granules; reduces the yield strength of the material; accelerates mass transfer as a result of an increase in the concentration of bulk vacancies of the crystal lattice and linear defects-dislocations. As an example, some effects of ultrasonic effects on the process of self-propagating high-temperature synthesis-pressing of compact solid alloys of SHTM -2 and SHTM -3 grades are given (see Table 11). Ultrasound leads to a decrease in the size of carbide granules, a decrease

in the hardness dispersion along the volume of the hard alloy alloy, and an increase in the flexural strength.

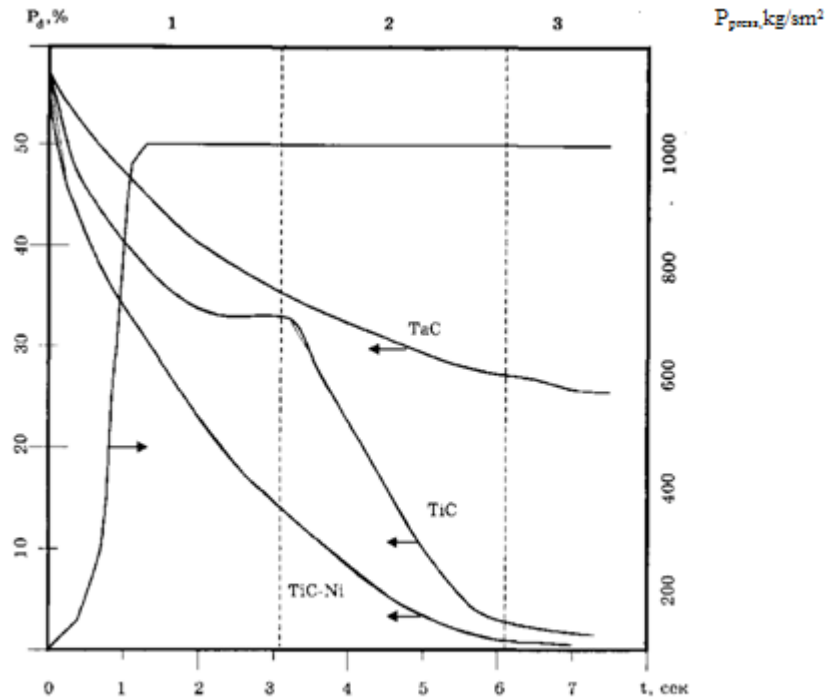

Fig. 37. The mechanism of densification of combustion products in the process of SHS-compacting: 1 - the slip zone of grains; 2-region of plastic deformation of grains; 3-region of diffusion pore healing.

Table 7

Influence of ultrasonic fields on properties of alloys of SHTM

Brand alloys	Properties of alloys obtained without an ultrasonic field				Properties of alloys obtained in an ultrasonic field			
	Granule size, microns	Hardness dispersion, HRA	$\sigma_{bending}$, kgf / mm ²	Conditional units of wear resistance at cutting	Granule size, microns	Hardness dispersion, HRA	$\sigma_{bending}$, kgf / mm ²	Conditional units of wear resistance at cutting
SHTM 2	6,0	0,18	110	-	3,5	0,07	130	—
SHTM 3	3,2	-	88	1	2,5	-	110	1,7

This is a type of technology in which the hot, porous products of SHS that do not have time to cool down are densified by external force effects (pressing, extrusion, rolling, blasting). The goal is to produce non-porous materials and products of a given shape, using the plastic properties of the combustion product at high temperatures. Power SHS-compacting has received the greatest development for the manufacture of products from hard alloys: cutting inserts, dies, rolls, electrodes for surfacing and electrospark alloying, targets for magnetron and cathode sputtering, etc. Especially promising is the force SHS-compacting for filling the market of products from new non-wolfram hard alloys.

Most of the developments in the field of force SHS compaction were carried out at the Institute of Structural Macrokinetics and Materials Science Problems.

To produce hard alloys, metal powders (Ti, Cr, Ni, Mo, Cu, etc.) and nonmetals (C, B, etc.) are used. Sometimes powders of steels and refractory compounds (TiN, AlN, NbC) are used. The initial charge mixture is prepared in such a way that the self-propagating high-temperature synthesis is carried out by a highly exothermic reaction, for example, $\text{Ti} + \text{C} \rightarrow \text{TiC}$ or $\text{Ti} + 2\text{B} \rightarrow \text{TiB}_2$, and the remaining components play the role of binding and alloying additives. Since the formation of hard alloys in the case of force-based self-propagating high-temperature synthesis-compaction occurs under extreme conditions of synthesis ($T = 2000-3000^\circ \text{C}$, $t = 0.5-15 \text{ s}$), their phase composition and structure have practically no analogues among known industrial hard alloys, obtained by specifying the powders of refractory compounds and a metal binder. Therefore, new non-wolframic hard alloys synthesized with self-propagating high-temperature synthesis -compilation, were called SHTM -synthetic hard instrumental materials. They are based on carbides, borides, nitrides, carbonitrides and other compounds of refractory metals (Ti, Zr, Nb, Ta and others). Depending on the tasks in the Institute for Structural Macrokinetics and Problems of Materials Research, several grades of TRIM alloys have been developed, differing in composition, mechanical properties and behavior under different operating conditions.

High-strength alloys of SHTM -1B / 3 grades (TiC-TiB_2) + Cu, SHTM -3B composition ($\text{TiC-Cr}_3\text{C}_2$) + Ni and SHTM -5 compositions (TiC-TiN) + (Ni-Mo) have a hardness of 91.5 up to 93.5 HRA and are used for the manufacture of cutting plates with high cutting ability. High-strength alloys of SHTM -2 grades of composition $\text{TiC} + \text{Ni}$ and SHTM -2A of $\text{TiC} + (\text{Ni-Mo})$ composition have bending strength from 1000 to 1800 MPa and are used for manufacturing armored plates and die tools. The alloy of the SHTM -ZV composition (TiC-CrC_2) - steel has a high scale resistance, and the SHTM -4 alloy of the TiB-Ti composition has a high resistance to thermal shock, so these alloys are used for making tools for hot working with pressure.

Along with the homogeneous solid alloys of the SHTM group in the technology of power self-propagating high-temperature synthesis - compacting, the production of functional gradient materials (FGM) has been mastered. materials with a variable composition by volume, the SIGMA brand. Carbide gradient plates of TiC-Ni composition of two types are obtained: with symmetrical and asymmetric distribution of binder Ni (SIGMA-1 and SIGMA-2). While maintaining a high hardness, they differ considerably in their toughness.

In addition to carbide materials and products, TT-3 technology has been successfully used for the production in one stage of targets for the spraying of coatings, for the creation and use of heat-resistant structural materials based on TaC, HfC, high-temperature heaters from MoSi₂, etc.

If the process of obtaining carbide products by methods of powder metallurgy is multi-stage and long-lasting: the synthesis of refractory compounds, molding, sintering, then in SHS-compacting technology it is one-stage and fast, since here the synthesis of refractory components of hard alloys and the compaction of hot synthesis products to a non-porous state are combined in the same technological stage. This allows not only to synthesize new solid alloys, but also to significantly increase productivity in comparison with industrial methods of sintering and hot pressing. Economic analysis shows that SHS-compacting is most effective for obtaining large-sized and unique products. The reason is that the dimensions and mass of the products produced in the case of force SHS compaction are not of fundamental importance, since there is no need to use external heating devices, which dramatically simplifies and reduces the cost of the equipment used, and high rates and temperatures of chemical interaction cause fast and uniform heating even large masses of material.

6.4 SHS– welding

The main task is a strong, permanent connection of refractory parts from heterogeneous or homogeneous materials by means of processes and products of SHS. SHS is a source of high temperature, and the SHS product is a welding material.

Usually, for the welding process, the SHS process is carried out in the gap between the parts to be welded so that a high temperature melt is formed. To increase the power of heat generation through the charge, electric current is usually passed through and an electrothermal explosion is carried out.

A good contact of the combustion products with the details is ensured by the detailing by small efforts.

The main advantage of SHS welding is the ability to make non-detachable joints of difficult-to-weld materials such as graphite, titanium, steel, tungsten,

molybdenum, etc. The strength of the weld is at the level of strength of the welded materials.

6.5 Technology of gas-transported SHS-coatings

For the implementation of the technology, gas transport additives (for example, iodine) and coated parts are introduced into SHS-burden. In the process of combustion, the gas transport transport of reagents to the surface on which a chemical reaction occurs (the same as in the bulk of the substance) is carried out, with the formation of the desired SHS product in the form of a coating. The coating scheme is shown in Fig. 59.

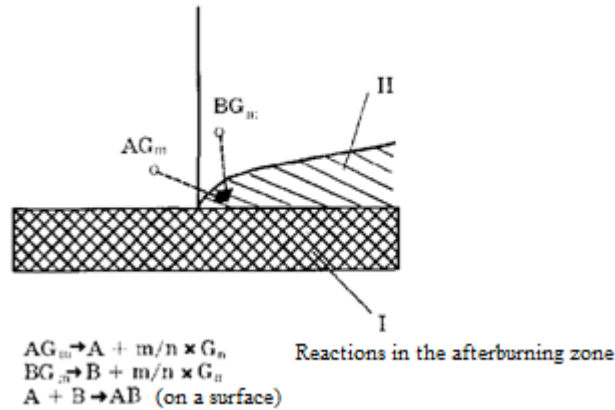
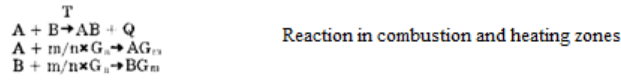
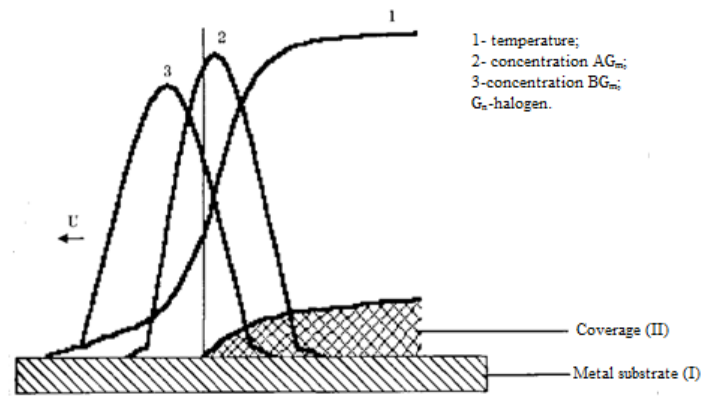
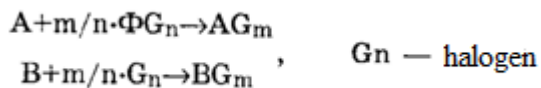

Fig.38. Scheme of application of gas-transported SHS-coating

Due to the main solid-state reaction of SHS between the elements A and B, the combustion front propagates with the velocity U_h over the powder mixture. In this case, in the zone of heating of the combustion wave reactions can occur:



At low temperatures, gaseous compounds are formed, and at high temperatures these compounds decompose. Gaseous compounds are first deposited on the surface of the article, and the formation of the original coating of A_x-B_y occurs at high temperatures. The length of the diffusion path of a volatile halide of the same order with the width of the heating zone is ~ 0.1 mm.

By combining different carriers, regulating the composition of the charge and the stepwise nature of its reaction, it is possible in one process to obtain complex multicomponent coatings (borides, silicides, intermetallides, others) with a thickness of 5-150 μm .

Currently, two methods of coating in the combustion mode are implemented: reactor and open. Each of them has its own merits. The reactor is used to supply an inert gas to the mixture, which prevents oxidation from coating. The open method uses systems that do not require an inert medium and can be implemented in the air. These include, first of all, aluminum-magnesium-thermal systems.

When implementing gas-transported SHS-coatings, different raw materials are used. Conditionally it can be divided into three classes:

1. Elements in the form of a mixture of metals and metal with nonmetal (Ni + Al, Ti + Al, Ti + B, Zr + Si).
2. Oxide systems ($\text{Cr}_2\text{O}_3 + \text{Al}$, $\text{B}_2\text{O}_3 + \text{Al}$).
3. Ores and wastes of production.

6.6 SHS-metallurgy

A wide range of mixtures of metal oxides with a reducing agent and nonmetal is capable of burning. The products of their combustion are carbides, borides, silicides, nitrides, simple and composite oxides, hard alloys, cermets. For mixtures in which the thermal effect is > 1000 cal/g, the combustion temperature exceeds the melting point of the combustion products, and therefore after crystallization they are obtained in cast form.

The chemical scheme for obtaining cast refractory compounds and hard alloys can be represented as:

$$\sum_{i=1}^{N_1} \vartheta_i A_i + \sum_{i=N_1+1}^{N_2} \vartheta_i A_i + \sum_{i=N_2+1}^{N_3} \vartheta_i A_i \rightarrow \sum_{j=1}^{M_1} \vartheta_j B_j + \sum_{j=M_1+1}^{M_2} \vartheta_j B_j + Q, \quad (30)$$

where $(i + 1) \div N_1$ are the starting oxides (CrO₃, TiO₂, Ni₂O₃, MoO₃, FeO),
 $i = (N_1 + 1) \div N_2$ - reducing metals (Al, Mg),
 $i = (N_2 + 1) \div N_3$ - nonmetals (C, B, Si, N₂, SiO₂, B₂O₃),
 $j = 1 \div M_1$ - carbides, borides, silicides, nitrides Cr, Ti, Ni, Mo, hard alloys,
 etc.

$j = (M_1 + 1) \div M_2$ - oxides of metal-reducing agents (Al₂O₃, MgO) and other condensed and gaseous combustion products.

The chemical scheme for obtaining cast composite oxides is:

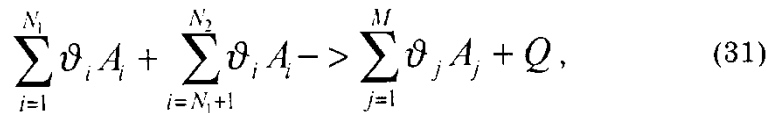

where $i = 1 \div N_1$ - initial oxides; $i = (N_1 + 1) \div N_2$ - reduction metals (Al, Mg, Ti); $j = 1 \div M_1$ - lower oxides and oxides of metal-reducing agents. For example: CrO₃ + Cr → Cr₂O₃, 2CrO₃ + 2Al → Cr₂O₃ + Al₂O₃, and so on.

The technological scheme of preparation, carrying out experiments at experimental industrial plants and operating time for testing for all variants of synthesis is the same and includes drying components, dosing, mixing, filling in a mold, synthesis in a reactor (stationary or centrifugal), disassembling the mold and extracting a cast material or article. If necessary, the ingots and articles are machined.

SHS of cast refractory materials proceeds in stages. In the general case, four main stages can be distinguished: combustion, phase separation, cooling and crystallization of liquid products, phase transitions.

Regularities of the process

Combustion in high-calorie mixtures of metal oxides with reducing agents and non-metals is accompanied by a strong melt dispersion and proceeds in an explosive mode. The increased gas pressure (argon, nitrogen, air) suppresses the spread and transfers combustion to a controlled steady-state regime, Fig. 49, where $\eta_{\text{ш}} = [(M_0 - M_k) / M_0] 100\%$, M_0 and M_k - are the initial and final masses. With the suppression of the spread, the burning rate can be varied several times, varying the pressure, the initial temperature, the composition of the mixture, and the dispersity of its reagents, Fig. 39

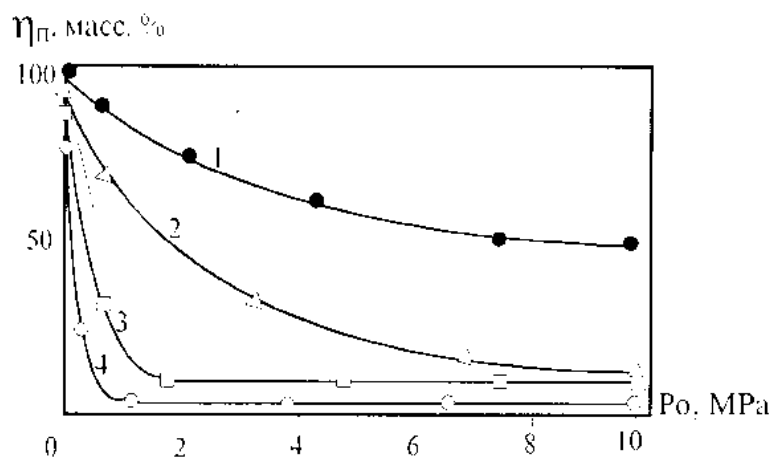

Fig. 39. Effect of initial argon pressure (P_o) on the loss of substance during combustion (η_{π}). Initial mixtures:
 1 - CrO_3 : Al: C, 2 - MoO_3 : Al: C, 3 - WO_3 : Al: C, 4 - V_2O_5 : B_2O_3 : Al

The output of the "metallic" phase (carbides, borides, hard alloys, etc.) in the ingot can be controlled in full by changing it from the calculated value to zero by diluting the mixture with "cold" compounds and inert additives. This allows to obtain three classes of materials: divided, graded (partially separated) and cermet (mixed). All three of the listed possibilities have found use in practice.

In the general case, during the synthesis, three phases are formed: a cast layer, a dispersant and gaseous products. For the case of complete phase separation, the chemical composition of the condensed phases is shown in Fig. 40

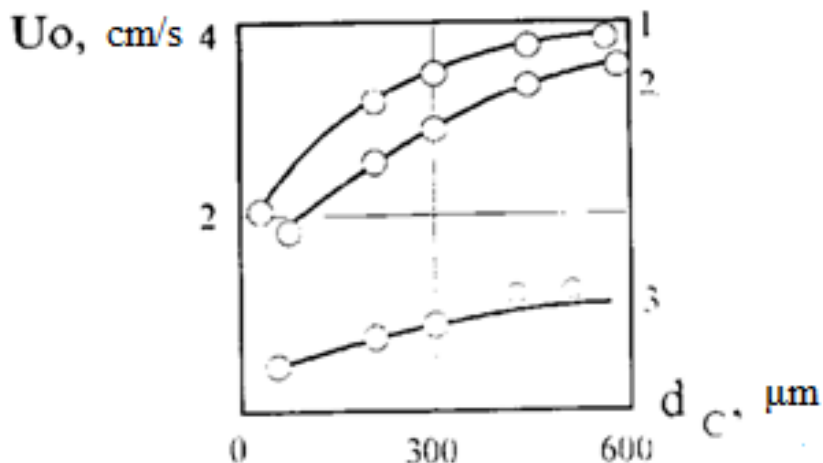

Fig. 40. Effect of carbon dispersion (d_c) on the linear steady-state combustion rate (U_c). Initial mixtures:

1- WO_3 : CoO : Al : C , 2- WO_3 : Al : C , 3- CrO_3 : Cr_2O_3 : Al : C

Each of the phases contains the entire set of initial elements, but the mass ones are different. The metal phase contains, mainly, the target elements and Al as the main impurity. The oxide layer and the dispersant consist mainly of Al_2O_3 . Chromatographic analysis showed that the gas phase of the combustion products in an argon atmosphere contains, after cooling, CO and C_2H_2 . As the size of the carbon particles increases, the mass of the gas decreases.

A local analysis of the slag layer showed that the target elements in it are contained both in the form of a solution of the initial oxide in Al_2O_3 , and in the form of small metal coronets.

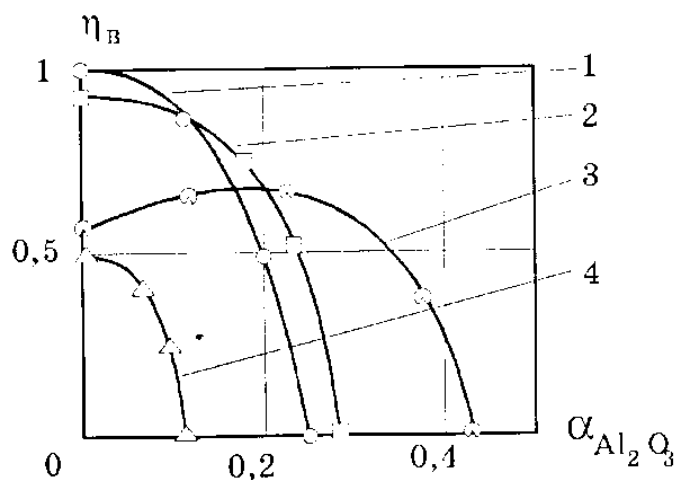

Fig. 41. Effect of the mass fraction of alumina in the initial mixture (α -Al₂O₃) on the completeness of the output of the metal phase in the ingot (η_v). Initial mixtures: 1-WO₃: CoO: Al: C, 2-MoO₃: Al: C, 3-CrO₃: Al: C, 4 -V₂O₅: Al: B₂O₃

Experiments in two-component systems CrO₃-Cr (Al, La, Ti, etc.) with incomplete reduction of CrO₃ to Cr₂O₃ have shown that their combustion products are cast oxide materials in which the metal phase is practically absent.

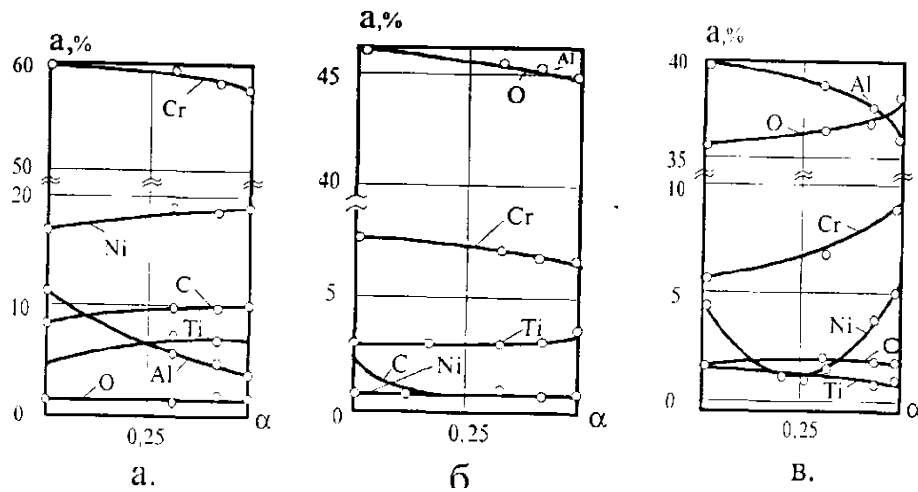

Fig.42. Effect of the composition of the initial mixture a on the chemical composition of the metallic (a) slag (б) and dispersed (c) phases. The starting mixture: $(1 - \alpha) (\text{CrO}_3 + \text{TiO}_2 + \text{NiO} + \text{Al} + \text{C}) + \text{Cr}_2\text{O}_3$

The investigations revealed the possibility of SHS-cast materials, including chromium carbides, in non-mixed (layer) systems, their chemical composition being little different from the composition of cast products obtained in the mixed systems. The results of the chemical analysis of cast combustion products indicate that the "metallic" phase, as a rule, contains a deficit of non-metal and an admixture of a reducing agent (Al, Ti, etc.). In connection with this, a study was undertaken aimed at obtaining higher phases with the necessary nonmetal content and reducing the content of impurities in cast refractory compounds and hard alloys. The main attention is paid to obtaining carbide systems from mixtures of metal oxides with aluminum and carbon.

Studies have shown that the main methods for solving the problem for carbide systems are the use of large-dispersed graphite (40-500 μm) as carbon, the creation of aluminum deficiency in the initial mixture (5-10%), the use of a complex

reductant (Al + Mg) and the introduction of the oxidant into the starting mixture (KC10₄). In the framework of these studies, cast Cr₃C₂, Cr₇C₃, Mo₂C, Mo₃C₂, WC-W₂C, TiC-Cr₃C₂, VC, WC-Co, Cr₃C₂-TiC, Cr₃C₂-Ni, etc. were obtained. with a content of impurity aluminum from 0.5 to 1% by weight.

Another technique that allows to reduce the Al content to 0.1% by mass is the chemical treatment of ingots with hydrochloric acid, during which the cast material breaks down into granules and their surface is cleaned of impurity aluminum. Completely aluminum is removed from the ingot when it is replaced in the original charge with Ti. Thus, carbides of chromium and titanium-chromium carbide were obtained. Approaches that make it possible to obtain pure, practically single-phase, cast borides (CrB₂, CrB₂-TiB₂, CoB, NiB, MoB₂, etc.) and silicides (V₃Si, MoSi₂, CrSi₂-TiSi₂, etc.) are analogous to those discussed above.

Influence of external fields

In experiments it was shown that mass electromagnetic and ultrasonic fields significantly affect the combustion and composition of products of SHS-metallurgy: intensify combustion and chemical transformation, expand the limits of combustion, allow the use of cold mixtures to produce cast materials and protective coatings. The most powerful influence is exerted by mass forces (overloads).

Thus, experiments carried out in a centrifugal installation at atmospheric pressure showed that, with increasing overload, the spread of the mixture during combustion decreases strongly, and the burning rate can vary by more than an order of magnitude (Figure 43). The possibility of burning in the field of centrifugal forces and the nature of the dependence of the combustion rate on overloading are affected by the dispersity of the nonmetal and the caloric content of the initial compositions.

The effect of centrifugal force makes it possible to vary the completeness of the phase separation within a wide range, and also to implement it for "cold" systems. Overload has little effect on the concentration of metal elements in the ingot, but it has a marked effect on the carbon content, and the trends of influence for compositions with coarse and fine carbon are opposite. Centrifugal acceleration has a significant effect on the microstructure of cast hard alloys, grinding the carbide phase granules more than 3-5 times.

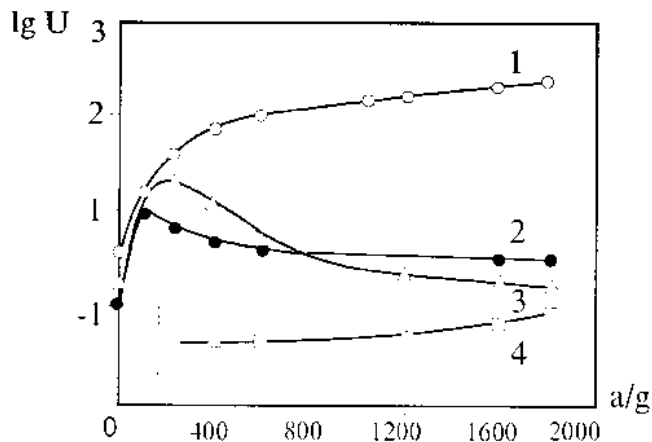

Fig. 43. Effect of overload on the burning rate. Initial mixtures:

1- $V_2O_5 + Zr$;

2- $FeO + Al$;

3- $FeO + TiO_2 + Cr_2O_3 + Al + C$;

4- $FeO + Cr_2O_3 + V_2O_5 + Al + C$

7 Scientific principles of process control and products SHS compacting

The creation of scientific principles for managing processes and products is an important and global task facing any new problem and new phenomenon. The macrokinetic characteristics of SHS processes, the structure and properties of the synthesis products are determined by the multitude of physical, technological and chemical properties of the powders of the initial reagents and their exothermic mixtures, the initial temperature, the size of the charge briquette, the gas pressure, the composition and the presence of external physical influences, other parameters inherent in a particular technological type SHS processes. Therefore, in order to develop scientific principles for the management of SHS processes and products, it is necessary to establish the patterns of influence of these parameters on the structure and properties of the target product.

The technology of power SHS-compacting, consisting in combining the combustion process with the pressing of hot synthesis products, is one of the most promising in the field of SHS. A significant amount of research is devoted to the development of new materials based on carbide and titanium diboride using the SHS-compacting technology.

So, in the works of E.A. Levashov A.N. Pityulin, A.S. Rogachev experimentally studied the effect of dispersion of the initial titanium powder (D), the density of the reaction mixture $Ti + C$ (θ) and the initial mixture temperature (T_0) on the granules size of titanium carbide (r_k). In these experiments, the carbon black of grade P804T was used. The dispersion of titanium varied over a wide

range: from 2-20 μm (magnesium-thermal powder TM-2T) to 1 000-1 500 μm (crushed titanium sponge using the hydrogenation-dehydrogenation technology of PTX5-1).

It has been experimentally established that with an increase in the size of titanium particles, the average size of carbide granules in compacted synthesis products increases from 2-3 to 20 μm (Fig. 44a). An important parameter of the synthesis is the density of the initial mixture of titanium with carbon. Its variation in the range 0.3-0.65 for any dispersion of the titanium powder leads to an extreme dependence of r_k . From Fig. 48b it is seen that in this range of charge densities the size of carbide granules changes by a factor of two.

Very important for explaining these regularities were the studies of the effect of preheating charge-charge briquettes on the granules size of titanium carbide. The heating of the charge Ti + C to 300 $^{\circ}\text{C}$ resulted in the grinding of the granules from 5-6 to 1-2 μm . Comparing the results with known data on the effect of D , θ , T_0 on the macrokinetic parameters of combustion, it is noted that the parameters that increase the conversion depth in the combustion front lead to a refinement of the structure of the products synthesized. On the contrary, the factors leading to the formation of non-stoichiometric titanium carbide, despite the lower combustion temperature, contribute to the formation of coarse-granulated titanium carbide. The extremum on the $r_k(\theta)$ dependence is determined by the maximum of the rate, combustion temperature and the depth of conversion in the combustion front.

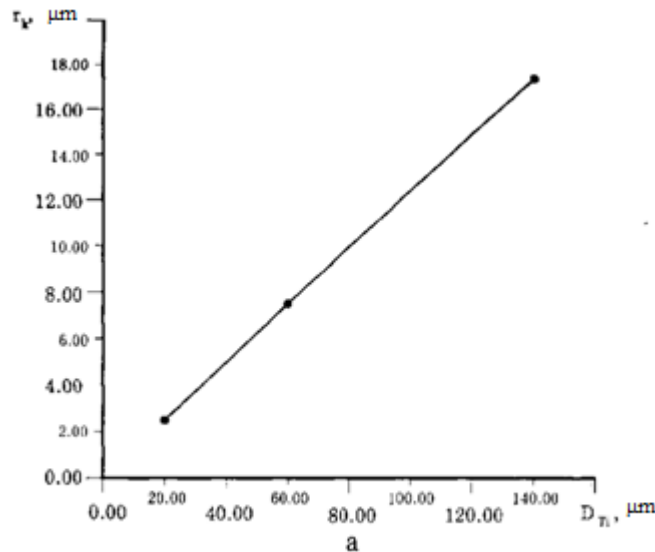

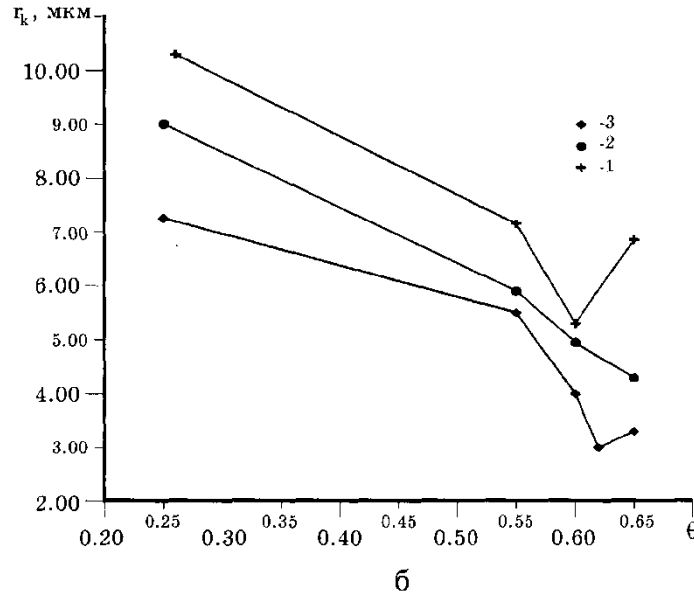

Fig. 44. Dependences of the average granules size of the carbide phase in alloys obtained by self-propagating high-temperature synthesis -compilation, on the dispersion of titanium powder in a mixture of Ti + C (a) and on the density θ of the charge briquette (b):

1 -Ti + C; 2-Ti + C + 20% Ni; 3 -Ti + C + Cr + 10% Ni (TRIM-ST)

The advanced thesis on the structuring of titanium carbide found further confirmation in the studies of A.N. Pityulina, A.S. Rogacheva, E.A. Levashov, made in more complex multicomponent systems based on titanium carbide: Ti-C-Ni (SHTM -2), Ti-C-Ni-Cr (SHTM -3B), Ti-C-Mo-Ni-TiN-NbC-Co -Cr-Al (SHTM-5).

The presence of a metal of the iron group, for example nickel, leads to a decrease in the degree of defectiveness of titanium carbide over carbon, since the interaction of non-stoichiometric carbide with the nickel melt, the excess of titanium dissolves in nickel. This contributes to the formation of fine-granuled titanium carbide, since the granules of stoichiometric titanium carbide are less prone to coalescence.

The monotonic nature of the $r_k(\theta)$ dependences for the SHTM -2 and SHTM -3B alloys can be related to the fact that the addition of nickel increases the stoichiometry of the primary crystals of titanium carbide. Moreover, with increasing density of the charge briquette, the concentration of the iron group metal in the finely dispersed substructure of the melt of titanium, nickel (chromium) and carbon at the early stage of structure formation (primary crystallization) increases. In contrast to the above parameters of the SHS process, the SHS-compaction regimes do not have a significant effect on the granules size of the reaction

products. In a wide range of values (from 800 to 1,750 kgf / cm²), the noticeable effect of compaction pressure on the average size of carbide granules and the porosity of the SHTM-2, SHTM-3B, and SHTM-5 alloys was not detected. However, compared with the porous material obtained without compression, the structure of the compact product can be crushed by 2-3 times.

The effect of compaction pressure on the dimensions of the structural components is mainly manifested in materials in which there are no binding metal components with a lower melting temperature than the carbide and boride components. Thus, for example, an increase in the compaction pressure of hot TiC-TiB₂ alloy products (SHTM -1B/3) from 870 to 1750 kgf/cm² resulted in the grinding of carbide granules from 6.7 to 4.9 microns.

The search for effective methods for controlling the macrokinetic combustion parameters of the mixture led to the need for direct observation of the staging of the processes taking place in the combustion wave of real SHS systems in regions of the order of the size of the particles of the melting reagent. To this end, it is possible to effectively use the method of high-frequency filming, which makes it possible to observe the processes of formation of the reaction surface and chemical reaction in various systems. Similar studies in 1991 were conducted by E.A. Levashov, A.A. Milovidov in systems based on Ti-C when using different grades of soot.

With the help of high-frequency Tseitlup cameras and SCS, filming of the SHS process was carried out. The shooting frequency varied from 2 000 to 6 000 fps at a scale of 2: 1, providing a forty-fold increase on the projection screen of the Kupava-16 mounting table. The system was additionally connected with a calibration timer with a frequency of 1 kHz. The Ti-C and Ti-C-Me systems were studied. Nickel and chromium were used as the metal bond. Carbon characteristics are given in Table 12. This method allowed direct observation of the propagation of the synthesis wave. At the same time, a certain amount of gases are formed, which are filtered in the direction of the combustion wave, both through the initial components and in the surface layer of the pressed pack, washing the unburned part of the charge. The rate of the gas flow significantly exceeds the speed of propagation of the combustion wave and reaches 70 m / s. Hot gas, heating the exothermic mixture of powders, increases the combustion temperature of the mixture. It is not ruled out that heated gases also play a decisive role in the reduction of oxide films on metal particles. Moreover, the organization of special channels in the burden charge, facilitating the infiltration of hot gases from the combustion zone into the initial components, significantly increases the burning rate U.

Table 12**Some characteristics of used soot grades**

Brand of high-active carbon black	S, m ² / g	d, μm	Mark of low-active carbon black	S, m ² / g	d, μm
Π514 (ΠМ-50)	50-57	0,042	Π705 (ΠМ-30В)	20-26	0,13
Π324 (ΠМ-75)	75-82	0,033	Π803 (ΠМ-15)	13-15	0,15
Π234 (ΠМ-100)	95-100	0,029	Π804Т (ΠМ-15ТС)	13-16	0,12
К354 (ДГ-100)	90-100	0,027	Т900 (ТГ-10)	12-16	0,31

The intensifying role of gas evolution is confirmed by the results of filming a combustion wave in a briquette containing stratum parallel and perpendicular to the direction of propagation. The burning rate in parallel channels is, on average, 2 times higher than the burning rate of the same mixture in a volume that does not contain favorable gas escape routes. On the contrary, the output of the combustion wave per channel perpendicular to the direction of propagation leads to a certain stop and a decrease in the value of U . The combustion front near the parallel channels arches, forming a wedge of stable shape. Going to the perpendicular channel, the wedge disappears, a relatively flat flame front is restored.

The structure of the combustion wave of mixtures including carbon black of grades Π705, Π803, Π804Т, Т900 is represented by four areas: initial components, heating, reaction and pre-reaction regions. The reaction area consists of foci localized near the fusible reactant particles, since the shape of these foci depends on the size and shape of the Ti particles. Gray areas are initially formed, and then bright flashes appear in their place. From the moment of the formation of gray areas (pre-fires) to the outburst, an average of $2 \cdot 10^{-3}$ s takes place. According to the photometric data in the Ti-C-Ni system, the temperature of the gray areas is in the range of 1 400-1 700 K, while in the source it reaches 2 200-2 700 K.

Thus, if at small magnifications the observed combustion front is flat and combustion is characterized by a certain constant rate U , then at large magnifications, due to the structural inhomogeneity and heterogeneity of the charge, the nonstationarity is clearly traced. After another outbreak and the appearance of the furnace, a period of depression begins. The front, as it were, slows down and "waits" until a surface is formed that is sufficient for the reaction.

According to the filming of the surface of burning samples (regardless of the shape and size of the original titanium powder), three variants of the origin of the foci can be distinguished. In the first case, before the combustion front, for a time of at least $3 \cdot 10^{-4}$ s, round-shaped precursors appear. After 10-3 seconds in their place there are foci in the form of a ring or a horseshoe. In the second case, the

furnace completely repeats the size and shape of the rounded pre-fences. After $5 \cdot 10^{-3}$ s, the temperature of these foci significantly decreases. Finally, in the third case, bright spot flashes occur in the heating zone. The stage of formation of visible pre-foci is absent.

The maximum size of the center R_0 depends on the dispersity of the R_1 of the titanium powder. Thus, for $R_1 < 50 \mu\text{m}$, $R_0 = 120 \mu\text{m}$, and for $R_1 > 160 \mu\text{m}$, $R_0 = 300 \mu\text{m}$. When using a non-dispersed polydisperse titanium powder, the IITM value R_0 does not change and is $300 \mu\text{m}$. It is noteworthy that in the latter case small foci with $R_0 = 120 \mu\text{m}$ initially form before the combustion zone. Further in the intervals between small foci, larger ones are formed, and during this time the front runs from small foci forward.

The presence in the exothermic mixture of a melting metal powder (Ni or Cr), which has an affinity for carbon, is smaller than that of titanium, affects the brightness of individual furnace. On the same compositions of brightness, the furnace close in size and shape often differ. This thermal microheterogeneity is probably due to the dilution of the reaction region with respect to the inert component.

In the propagation of the combustion front in mixtures containing carbon blacks of grades П514, П324, П234, K354, the structure of the synthesis wave changes. In the preheating zone, this method is not observed. The front is a set of large furnace ($R_0 \sim 1 \text{ mm}$) growing toward the cold burden. The resulting pre-furnace are the essence of the capillary spreading of a melt based on titanium. In this connection, let us imagine the following scheme for placing titanium particles in the surface layer of the charge briquette. The particle may be located on the surface of the briquette or at some distance from the surface. In the second case, the region of capillary spreading can cross the surface of the briquette either along the plane or at a point. After melting of the titanium particle, capillary spreading starts, ie, the wetting process, in which the main reaction of the components does not have time to start, although partial dissolution of carbon with the formation of thin layers of primary products is completely permissible. The completeness of spreading is determined by the activity of carbon, the size of titanium particles, the porosity of the briquette.

After the initial spreading, a source is formed, the shape of which depends on the variant of the placement of the Ti particle in the surface layer of the charge. If the particle is located on the surface of the briquette, then after the capillary spreading in the place of its location, a circular-shaped focal point is formed, in the second case, a center of round shape. Finally, when the initial spreading region intersects the sample plane at the point, a point furnace is observed.

Forms of foci are a direct confirmation of the staged nature of elementary processes. In any case, the processes of formation of the reaction surface and the

basic chemical interaction are separated in time. The subsequent growth of the foci is evidently due to the continued filtration of the reagent metal to the unreacted surface of the soot.

The absence of starting spreading regions in the case of highly active carbon blacks indicates that the formation of the reaction surface and the chemical interaction proceed at a given temporal resolution of the method practically simultaneously, apparently because of the high rate of the interaction itself and the relatively low rate of formation of the reaction surface.

Since the reaction surface in these systems is formed as a result of the hydrodynamic transfer of the fusible reactant to the more refractory component by means of surface tension forces, it is not difficult to estimate the characteristic time of capillary spreading:

$$\tau_k = 2 \mu l^2 / \sigma r_3 ,$$

Where μ , σ - viscosity and surface tension of titanium melt, respectively; r - the characteristic size of the capillary; l is the depth of the initial spreading.

To estimate l we turn to the model of the unit cell. In the approximation of the total spreading of a particle, the value of l can be determined from formula

$$l = R_3 - R_1 = R_1 \{ [\rho_1 / \rho_k (1 - \Pi) \varphi_1]^{1/3} - 1 \} .$$

Here R_3 - the size of the unit cell; ρ_1 - the density of Ti; ρ_k - the density of a compact material of a given composition; Π - is the porosity of the briquette; φ_1 - the mass fraction of Ti in the mixture. After setting the known quantities in (27) ($\rho_1 = 4.5 \text{ g / cm}^3$, $\rho_k = 4.0 \text{ g / cm}^3$, $P = 0.4$, $\varphi_1 = 0.6$), we obtain $l \approx 0.5 R_1$.

The characteristic size of a capillary can be defined as

$$r_3 = 2 / S_n \rho_k (1 / \rho_{\text{OTH}} - 1) .$$

Here, S_n - the specific surface area of the powder mixture, determined predominantly by the specific surface area S ; $\rho_{\text{OTH}} = 1 - \Pi$. If we substitute $S_n = 15 \text{ m}^2/\text{g}$, in (28), obtain $r \approx 10^{-5} \text{ cm}$, and $\tau_k \approx 0.5 R_1^2$. For example, for $R_1 = 300 \text{ }\mu\text{m}$, $\tau_k \approx 10^{-4} \text{ s}$. The latter coincides with the accuracy of the order with the actual time of formation of the pre-fence ($3 \cdot 10^{-4} \text{ s}$). The proximity of these times confirms the conclusion that the process is staged in the case of low-active carbon blacks with $S = 15 \text{ m}^2 / \text{g}$. Primary wetting process, and then there is a chemical reaction with the release of a large amount of heat.

The magnitude of the reaction surface at the time of the main reaction is determined by the ratio of the rates of wetting and reaction interaction or by the ratio of their characteristic times. If $\tau_k \ll \tau_p$ (τ_p - is the characteristic time of the reaction interaction), then the combustion has a markedly staged character. Otherwise ($\tau_k \gg \tau_p$), the reaction protrudes so quickly that it is not possible to practically separate the wetting and the chemical interaction.

We express the limiting relation τ_k/τ_p through S . After substituting (27), (28) into (26), and also taking into account the fact that $\tau_p \sim r_3^2 / D(T)$, we obtain

$$\tau_k/\tau_p = 0,02 \mu R_1^2 D(T) S^3 \rho_a^3 / \sigma \Pi^3,$$

where ρ_a -the absolute density of the mixture; $D(T)$ - the diffusion coefficient. Substituting the numerical values of the parameters $R_1 = 5 \cdot 10^{-3}$ cm, $\rho_a = 2.52$ g/cm³, and also assuming that the diffusion coefficient does not depend on the soot and is of the order of 10^{-7} cm²/s, we find $\tau_k / \tau_r \approx 10^{-4} S^3$. Thus, a two-stage character can be observed at $S \approx 10-20$ m²/g. When switching to carbon materials with $S = 50$ m²/g and higher, i.e., to highly active soot, the characteristic formation time of the reaction surface becomes much longer than the reaction diffusion time, and it is not possible to divide the stages using the technique used. This conclusion agrees with the experiment. It also follows from (29) that combustion can be transferred from the diffusion regime (two-stage) to the capillary one by increasing the dimensions of the titanium particles R_1 .

This method of high-speed visualization has found its development in the works of A.S. Rogachev and M. Varma in studying the structure of the combustion wave in nickel-aluminum and titanium-aluminum systems.

When developing multicomponent alloys based on titanium carbide, it is necessary to take into account the interrelation of macrokinetic combustion parameters of carbon-containing mixtures with the structure and properties of synthetic solid tool alloys of SHTM obtained by the technology of self-propagating high-temperature synthesis-compaction. Therefore, an important issue facing a technologist is to study the effect of the carbon material (soot) brand on combustion parameters, the structure and properties of compact alloys.

Thus, the experimental dependences $\ln C = f(\Pi)$ (where C - is the rate of sound and Π - is the residual porosity) for the SHTM -3B alloys obtained using different grades of soot are found:

$$\Pi = 1 / 2.12 \ln(9430/C).$$

Substituting in these equations the experimental values of the sound rate (C), we can calculate the porosity of the alloy. The smallest size of carbide granules and the highest values of strength, hardness, speed of sound (modulus of elasticity) and wear resistance of the alloy were obtained using soot of grades T900, P804T,

P705. It is in these cases that the conversion depth in the reaction zone is maximal in connection with the realization of the diffusion two-stage combustion regime.

For power SHS-compacting, it is of interest to combine the process with the action of shock waves and explosive loading. Dynamic compaction leads to a substantial grinding of the structural components and the formation of nonequilibrium states.

A promising development of the direction of the SHS-pressing technology is the combination of SHS with various types of rolling. The SHS-rolling technology in vacuum, developed at the Moscow State Institute of Steel and Alloys, E.E. Osinov, V.N. Chernyshev, E.A. Levashov, allows you to get various products in the form of strips, rods, stepped bodies of rotation from ceramic, ceramic-metal and intermetallic materials.

A variation of this technological direction is SHS-extrusion.

8. SHS-extrusion

The force SHS compaction in this process is terminated by squeezing the SHS product through the spinneret. Especially effective SHS-extrusion for the production of long products.

In order to optimize the technological regimes for obtaining high-quality products, A.M. Stolin and co-authors carried out modeling of thermal processes. Modeling allowed to develop a non-isothermal technique for calculating the tool, taking into account the specifics of the processes.

By the method of SHS-extrusion, electrodes for surfacing from nonwolfram hard alloys, electrodes for electrospark alloying, blanks for microspear, drills, step rollers, high-temperature heaters were obtained.

8 Formation of layer compositions on steel substrates

Experimental studies have shown that when burning the most "hot" mixtures of oxides with aluminum and nonmetals under pressure of gas on the surface of the steel sample, after burning and cooling of the melt of the combustion products, a cast coating is formed uniformly distributed and firmly adhered to the substrate.

From the analysis of the sections of the welded samples it follows that the coating is formed both by the target elements of the initial mixture and by the surface layer of the substrate. The thickness of the molten base layer, which is transformed into the composition of the coating, depends on the conditions of surfacing, the ratio of the masses of the charge of the steel substrate, the combustion temperature

The uniformity of spreading on the base is affected by the mass of the initial mixture, its combustion temperature, the formation of intermediate layers, gas pressure, etc. The minimum thickness of SHS coatings is 2-3 mm, and the maximum thickness of the sample is limited by melting the sample.

A wide range of coatings was obtained by the SAF deposition method: Cr, Cr-C-Ni, Cr-Ti-C-Ni, Cr-Ti-CB-Ni-Mo, Cr-B, Cr-Ti-B, etc. Chemical and local X-ray spectral Analyzes of "thin" (2-5 mm) and "thick" (8-25 mm) coatings showed that the elements that make up the cast coating are evenly distributed along its height, Fig. 54. In thick coatings, the iron content falling in them from the base reaches - 10% of the mass, in thin coatings it is substantially larger (up to 20-30%).

Metallographic and local X-ray analyzes reveal two zones in the surfacing: the actual coating and the transition zone. The coating itself consists of carbide, boride phases and a matrix based on Ni and Fe. Carbide and boride phases are carriers of high hardness (from 1,200 to 2,500)•10⁷ N/m². The micro hardness has no tendency in height and length of coatings and is distributed statistically.

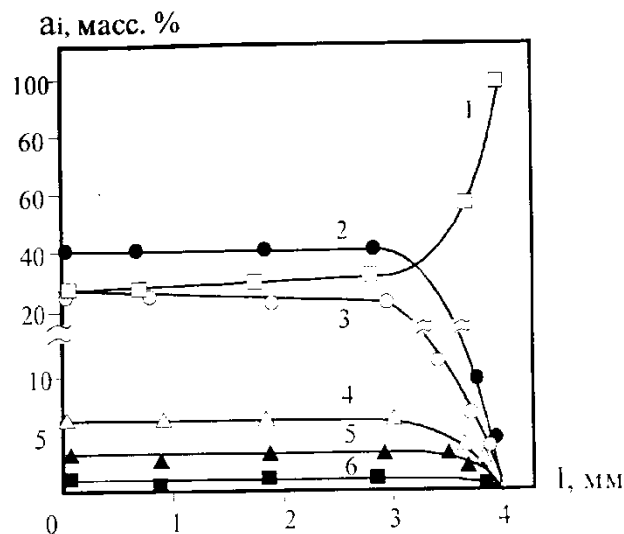

Fig.45. Distribution of elements along the thickness l of a "thin" cast coating. The starting mixtures: 1-Fe, 2-Cr, 3-Ni, 4-C, 5-Ti, 6-Al

Local chemical and X-ray phase analyzes of the welded samples revealed the following carbide phases: TiC (solution), Cr₃C₂ (Cr, Fe) γ C₃. The matrix is a solution based on Ni and Fe.

Centrifugal force has a powerful effect on all stages of surfacing: phase separation; spreading over the surface; formation of chemical, phase compositions and microstructure of cast coatings. First of all, it should be noted that under the influence of overload, thin coatings (up to 1 mm) were obtained, evenly distributed over the substrate. In addition, with increasing overloads, the Fe content in the cast coating decreases from ~ 30 to 1% by weight. (Figure 55). As a consequence, in the composition of carbide phases, the iron content decreases practically to zero, and their microhardness increases.

Models of the main stages of SHS-metallurgy

SHS cast refractory materials - a complex and multi-stage process. It can be divided into three main stages: combustion, phase separation and cooling of combustion products. Below we consider the mechanisms of the process at each of the stages, and for the first two we offer qualitative elementary mathematical models. The analysis furnaces on three-component systems such as metal oxide, aluminum and carbon.

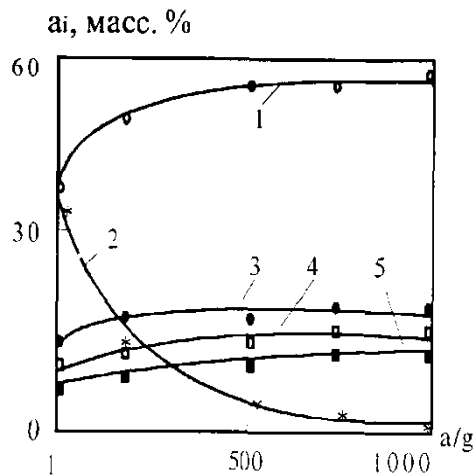
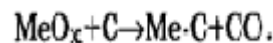
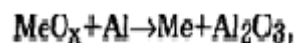

Fig. 46 Effect of overload (a/g) on the chemical composition of the "thin" cast coating. The starting mixtures: 1-Cr, 2-Fe, 3-N, 4-C, 5-Ti

Structural scheme of chemical transformation

In a combustion wave, a mixture of initial reagents undergoes a series of physical and chemical transformations, Fig. 56. At the same time, a continuous medium is formed in the heating zone after the initial oxide (MeO_x) melts, in which the droplets A1 and particles C are distributed. At the beginning of the chemical transformation zone, the droplets and particles interact with the initial oxide independently:



Then, after the formation of a "bridge" from Al_2O_3 between them, exchange reactions take place, and the carbonization of Me reduced by reaction (32) takes place:

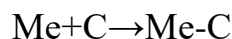

Thus, within the framework of the scheme considered, two condensed products - Me-C and Al_2O_3 , as well as gas-CO - are formed. In reality, according to thermodynamic data, other gases are formed: metal vapor and sub-oxides.

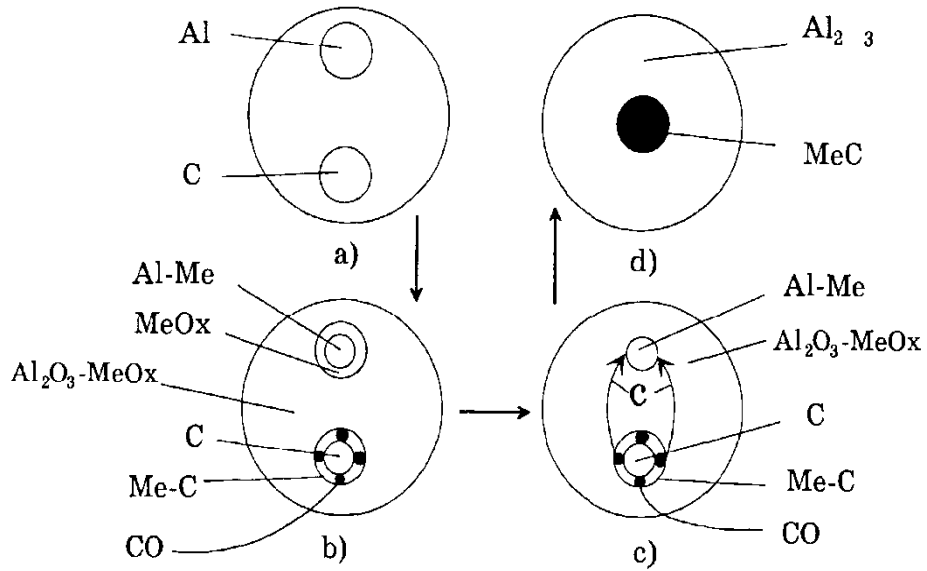

Fig. 47. Structural diagram of chemical transformations in a unit cell at different instants of time

Combustion

The relationship between the linear steady-state combustion rate (U_0) and the dimensions of aluminum particles (d_{Al}) and graphite (d_C) for the kinetic combustion regime can be obtained by solving the system of equations describing the combustion process in conjunction with the equation for heat exchange of carbon particles with a melt:

$$U_0^2 \approx \frac{1}{d_{Al}} \exp\left(-\frac{E}{RT_m}\right)$$

where E - the activation energy of the chemical reaction (1), T_m - the combustion temperature, depending on d_C and R - the gas constant. The qualitative dependence of T_m on d_C is shown in Fig. 57. There are two areas in the figure. In the first region, the carbon particles are rather small, actively participate in the endothermic reaction (33), competing with aluminum in the reduction of the initial oxide. In the second - large carbon particles practically do not participate in the recovery of the initial oxide, behave in the leading zone as inert, participating only in heat exchange and taking away heat for their heating. For the minimum ($T_{m, \min}$) and maximum ($T_{m, \max}$) values of the combustion temperature, and also for the $T_{m \text{ bond}}$ with the combustion characteristics in region II, the following formulas can be obtained:

$$T_{m,\min} = T_0 + \alpha_{Al} \frac{Q_{Al}}{c} \eta - \alpha_c \frac{Q_c}{c},$$

$$T_{m,\max} = T_0 + \alpha_{Al} \frac{Q_{Al}}{c},$$

$$T_m = \frac{T_0 + \alpha_{Al} (Q_{Al}/c)}{1 + \alpha_c / (1 + Z)},$$

where $T_0' = T_0 - \sum_i^2 \alpha_i (L_i/c)$; L_i - the heat of fusion of the initial reagents; α_i are their mass fractions in the initial mixture ($i = 1$ - oxide, $i = 2$ - aluminum, $i = 3$ - carbon); Q_{Al} and Q_C are the thermal effects of reactions (32) and (33) calculated on 1 g of Al and C; $Z = \tau_c/\tau_p$ is the ratio of the characteristic times of particle heating and stay in the combustion wave; $\tau_c = d_c^2 / 3\chi$ and $\tau_p = \chi / U_o^2$; χ - coefficient of thermal diffusivity of oxide melt.

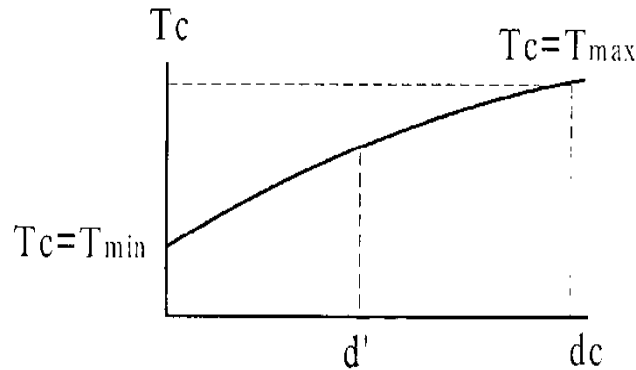

Fig. 48 Qualitative dependence of temperature in the leading combustion zone (T_c) on the size of carbon particles (d_c)

The analysis of formulas (37) - (40) gives an idea of the mechanism of the connection of U_o with d_{Al} and d_C obtained in the experiments. In addition, it follows from the analysis that the "detachment" mode is optimal for obtaining single-phase carbides, when the stages (32) and (34) are separated in the combustion wave, and the stage (33) is eliminated. To this end, the initial mixture requires the following relationship: $d_{Al} \ll d_C$. Target experiments, carried out by the method of variation of the duration of the stages and the ratios d_{Al} and d_C confirmed this conclusion.

The analysis of the burning processes of systems with incomplete reduction of non-stable oxides, mixtures with spatially separated reagents, and the influence of centrifugal acceleration on the synthesis process made it possible to create

elementary models, obtain formulas relating the rate with combustion characteristics, and explain the experimental results.

9 Mechanochemical processes in solid inorganic substances

Mechanochemical treatment is a simple effective method of changing physico-chemical properties and reactivity of solids and has recently been increasingly used to modify the properties of various materials [14, p.16; 52-59]. Among special methods, it is especially important to distinguish the preliminary mechanical activation of the initial reaction mixture.

Mechanochemical synthesis under conditions of intense mechanical activation of the reaction mixture is widely used to produce various compounds and materials, including using the SHS method.

With the simultaneous machining of several components of the mixture, deformation mixing and mechanochemical reactions occur. Mechanical grinding is a productive way of obtaining large amounts of nanopowders of various materials - metals, alloys, intermetallides, ceramics, composites. Also, work is presented in which the formation of carbon nanotubes was achieved using a mechanochemical method. As a result of mechanical grinding and mechanical alloying, complete solubility in the solid state of the reagents can be achieved, the solubility of which is negligibly small under equilibrium conditions.

Mechanochemistry is a field of chemistry that studies chemical and physico-chemical changes in substances in all aggregate states under the influence of mechanical energy. Mechanisms of mechanochemical reactions are multistage; their most important stages are the following: the initial deformation of the crystal structure of the reagents, the formation, accumulation and interaction of point and linear defects, the milling of substance into individual aggregates, the formation of metastable states in the contact zone of different phases, chemical homogenization and relaxation of the reaction products to the equilibrium state.

A distinctive feature of mechanochemical processes is a high dose of energy supplied to the processed material in a short period of time. With the help of this technology it is possible to obtain refractory compounds, which are the basis for obtaining structural and tool ceramics, new composite materials, anticorrosive and wear-resistant coatings

The purely physical processes of friction or grinding, associated with the application of mechanical forces, cause chemical reactions or changes in the reactivity of solids. A special class of such chemical processes was identified by V.Osvald in 1887, he also introduced the term "mechanochemistry" in the literature. If the main task of grinding is to obtain the maximum surface of the powder at minimum energy costs, the activation problem is the accumulation of energy in crystals in the form of defects or other changes in the solid that would

allow reducing the activation energy of the subsequent chemical transformation of the substance or improve the steric conditions for the process.

The essence of mechanical activation (MA) lies in the fact that under mechanical processing conditions both a decrease in particle size and an increase in the surface of solid reagents occur, as well as the accumulation of defects in the crystal lattice. The rate of solid-phase reactions in which one or more components are in the solid phase is determined both by the size of the interface of the reacting phases and by the specific reactivity. Consequently, after preliminary mechanical activation, chemical reactions accelerate, in addition, there is a decrease in the initial temperature of solid-phase syntheses of new materials.

In many reviews and monographs, known to date, on mechanochemistry gives a detailed analysis of the research of the process of grinding solid bodies in its multifaceted manifestation and the variety of physical and chemical phenomena accompanying deformation and destruction. As noted in the works of IA. Hint [59; 60], first, various researchers attributed various phenomena to mechanical activation: an increase in the rate of chemical reactions, an increase in catalytic activity, an increase in the strength and other characteristics of activated materials. As experience has shown, in all cases, mechanical treatment leads to a significant change in the structure of the material and a change in the energy state of the substance after its activation.

The last review on the mechanical activation of solids [summarizes the results of many years of research into the nature of mechanochemical processes. It is shown that MA is a set of phenomena that consist not only in the quantitative accumulation of defects, but also lead to a radical transformation of the structure, accompanied by a significant change in composition and chemical properties. Of the two thermodynamic parameters, realized under the action of grinding bodies on substance - temperature and pressure, the latter plays a decisive role as a cause of activation. Allowance for intergranular interactions in the study of the effect of pressure on mixtures of solids entering a solid-phase reaction is important. Komats showed that the number and area of contacts should be taken into account, since it is they, and not the ratio of the areas of the surface of the reacting particles, that determine the rate of the solid-phase reaction, at least at the beginning of the process. In some cases, the change in the reaction rate and the degree of conversion under the action of an external action can be considered as a sign of participation in the intermediate gas phase process. The result of the pressure action is also the changes that occur inside the solid particles themselves.

For the grinding and activation of solids, apparatuses of various designs are used, differing in the form of mechanical action on the substance: in one case it can be crushing, in others it may be impact, splitting, abrasion, etc. Modern grinders usually combine two or more types of such influences. For brittle materials,

crushing and shock effects are prevailing, for soft rubbing, for tearing materials, tearing forces are effective, etc. It should be noted that both the mechanics and the physics of the processes taking place in such apparatuses are still the subject numerous studies [63-65]. These principles are based on two basic principles: the pulsed nature of the process over time-the alternation of the processes of the appearance of the voltage field and its relaxation, and the local nature of the mechanical effect on substance in the MA-the voltage field does not arise in the entire volume of the solid particle, but on its contact with the other particle or working body.

If the mechanically processed substance represents a single phase, the relaxation of the voltage field can occur through different channels: heat generation, the formation of a new surface, the formation of various crystal defects, metastable polymorphic forms, amorphization of a solid, and chemical transformations. The share of each channel depends on the loading conditions (the supplied energy, the loading rate), the physical properties of the solid, the processing temperature, etc. Sometimes the relaxation channel can change in the course of the process. Thus, for example, an increase in the rate of development of the main crack in the destruction of crystals of salts of oxygen acids is accompanied by a change in the mechanism of their decomposition in the toe of the crack - thermal decomposition is replaced by mechanochemical decomposition. The change in the size of the particles subjected to machining is accompanied by a transition from the grinding process to the process of plastic deformation. The factors influencing the formation of the voltage field and the main channels through which relaxation occurs are shown in Figure 6. The left side of the scheme refers to grinding processes, the processes placed on the right side of the circuit are usually referred to as mechanical activation.

Grinding is carried out in order to obtain the maximum surface of the powder at minimum energy costs, and activation to accumulate energy in the form of defects or other changes in the solid that allow to reduce the activation energy of its subsequent chemical transformation or improve the steric conditions of the process.

There are two cases of mechanical activation. The first is when the time of mechanical action and the formation of the voltage field and its relaxation is greater than the time of the chemical reaction. Such processes are usually called mechanochemical processes. And the second - when, on the contrary, the time of mechanical action, the formation of the voltage field is less than the rate of chemical reaction, or in general when these two processes are separated in time.

The forms of energy storage during mechanical activation can be different. Usually they all boil down to the formation of defects in the activated crystals. Often the result of machining is plastic deformation and the associated formation

of linear defects - dislocations, ionic and atomic vacancies, interstitial ions. In addition, the angles between bonds can vary, and broken bonds can also appear, which in covalent crystals lead to the formation of free radicals, and in molecular k-amorphization.

Using the example of diffusion of helium atoms into metals and alloys, it has been found that the capture and transport of helium atoms to the volume of deformed metals occurs due to dynamic lowering of chemically excited potential barriers at defective plastic shear sites.

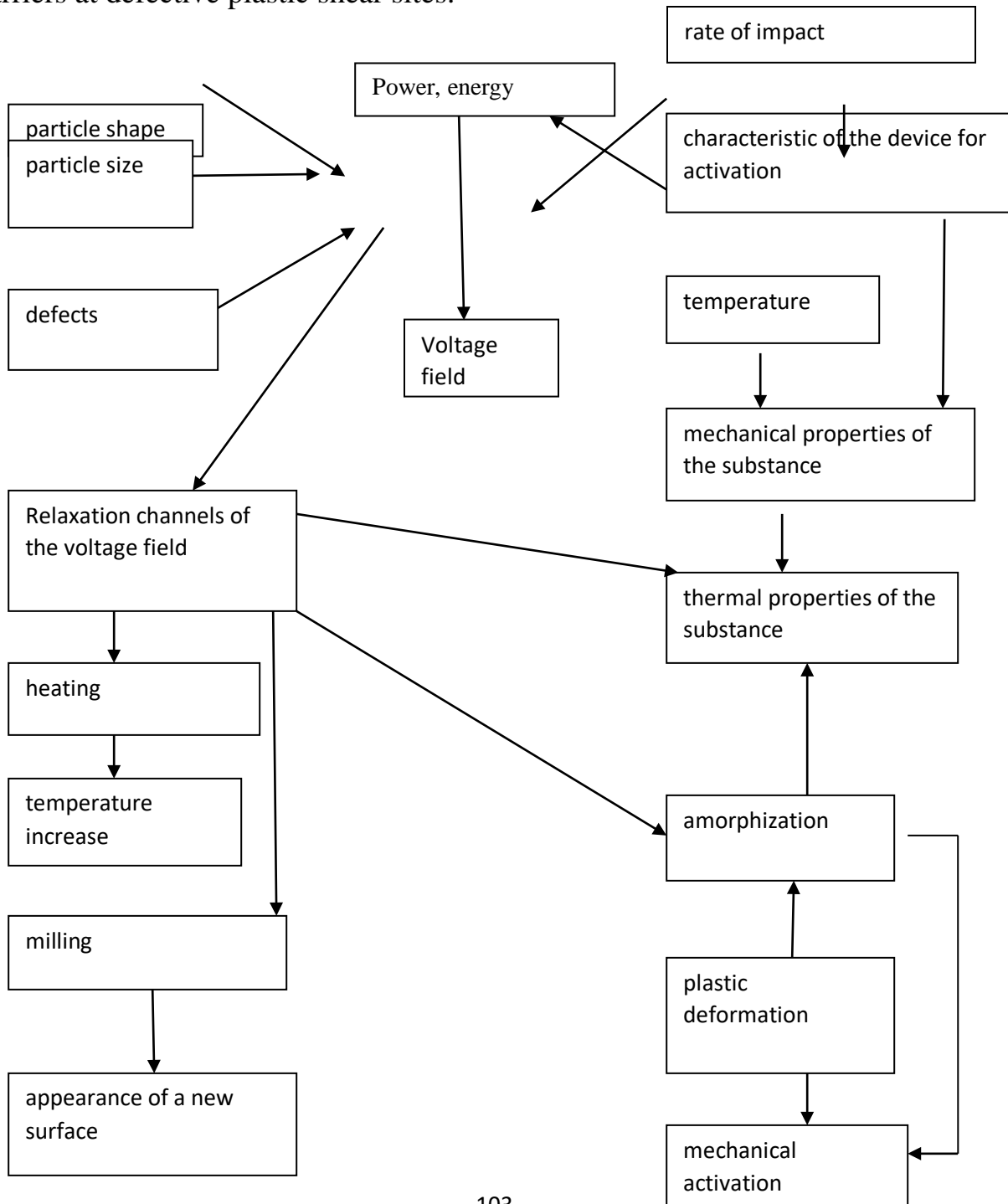

Figure 49 - Factors affecting the formation of the voltage field, and the main voltage relaxation channels

The results of a study of the thermal explosion of mixtures of 3Ni + Al composition after preliminary mechanical activation in a planetary ball mill are presented in A decrease in the initiation temperature and the effective activation energy of the reaction of the reagents to anomalously low values is established, which is associated with structural changes in the mixture. The modes of preliminary mechanical activation of the reaction mixture and realization of the thermal explosion are determined, which ensure solid-phase synthesis of monophasic intermetallide Ni_3Al .

In the dynamics of the transformation of a substance under the action of a mechanical action during activation, the role of a freshly formed surface is exceptionally large. The surface of failure is the region of active centers, caused by the rupture of bonds and the maximum defectiveness of the substance. According to the wave model of deformation and fracture of particles during grinding, the running, "shock" wave is discharged on the surface, as a result, the density of the substance decreases, and the surface layer becomes amorphous. The loosened surface actively interacts with the environment, for example, absorbing water vapor and atmospheric gases.

In the process of grinding, the surface of the particles is constantly in an excited highly active state. Proceeding from the notion of surplus surface energy, P.Yu. Butyagin substantiated the theory of short-lived active centers [71], which arise as a result of deformations of the surface zones of faults and cracks under the action of mechanical loads.

The application of mechanical action causes the following physical phenomena:

- initiates the emission of electromagnetic waves in a wide range, including sound and light;
- produces heat, which causes heating of the material to be crushed;
- SHTM ulates the emission of electrons and creates a potential difference;
- leads to disruption of the continuity of the material and increases the free surface of the substance;
- causes elastic and plastic deformation. Relaxation of deformations and residual voltagees in solids at low temperatures proceeds slowly enough, and, consequently, a substance subjected to the action of mechanical forces has a "surplus" energy reserve for a while;

- distorts the crystal lattice of minerals, is the cause of the appearance of point defects and linear dislocations carrying an appropriate stock of "excess" energy;
- through disruption of the continuity of the material to be crushed, leads to the rupture of the chemical bonds of the substance (mechanolysis, mechanocracking, etc.). The uncompensated chemical bonds or free radicals formed in this case have a reserve of "excess" energy;
- with fine grinding leads, ultimately, to particles of this size, which are commensurable with the parameters of the crystal lattice. Further dispersion leads to a rearrangement (a change in the crystal lattice, amorphization) with a corresponding change in all the thermodynamic characteristics.

The change in the reactivity of solid materials under the influence of mechanical activation is the result of all the phenomena listed above.

10. Contribution of Kazakhstan scientists to the formation and development of SHS-technologies

In the Republic of Kazakhstan, work on SHS was started under the guidance of G.I. Ksandopulo for the creation of refractories of the "Furnon". Currently, the Institute of Combustion Problems successfully works on the production of various composite materials by the SHS method.

To reduce the cost of production and expand the raw material base of SHS technology in the Institute of Structural Macrokinetics and Problems of Materials Science have been launched, and in Kazakhstan, research has been developed on the use of mineral raw materials (ores and industrial wastes) in the technology of SHS refractories. The use of natural and secondary resources (chromite ore, dolomite, magnesite, blast furnace and refractory waste, scale, etc.) opens the prospect of obtaining inexpensive refractory materials in large quantities and their wide application in industry where the consumption of various refractories is several million tons in year.

In the Institute of Combustion Problems of the Kazakh National University. Al-Farabi developed a whole series of fire-resistant SHS-materials of the brand "Furnon", which can be used as:

1. Masonry solutions (welding composition) for highly refractory and chamotte products;
2. Refractory concrete (ramming mass);
3. Refractory coating.

Several materials are based on the use of chromite ore, the commercial concentrate of which contains more than 50% of the mass. Cr₂O₃ and less than 5% by weight. SiO₂ (a large content of the SiO₂ phase is undesirable, since the refractory property of the material deteriorates). Such self-propagating high-

temperature synthesis-refractories exceed by their parameters the standard high-refractories.

As an example, we give the composition of the corresponding masonry SHS solution (wt%):

- chromite concentrate - 52.0;
- Iron scale - 25.0;
- Aluminum powder (PA-4) -13.0;
- magnesium sulfate ($\text{MgSO}_4 \cdot 7\text{H}_2\text{O}$) -10.0.

Chromite concentrate is the main oxidizer in the SHS reaction. Iron scale acts as an energy additive, ensuring reliable synthesis throughout the material. Aluminum powder serves as a reducing agent. Magnesium sulphate is a binding component, which gives the masonry solution the necessary plasticity, and in the course of natural drying before the SHS, providing the entire construction of the furnace lining the necessary building strength.

Masonry SHS-solution is prepared according to the following technology. The components are dried at a temperature of 400 °C for 2 hours. They are then ground in a ball mill for 30 minutes to a fraction of 100 µm, with a ≤ 100 µm residue on the screen not exceeding 15%. In a mixer with forced stirring, in accordance with the formulation, magnesium sulfate is added and poured into water until complete dissolution with stirring. Then all other components are filled in accordance with the formulation and mixed until a uniform plastic mass of a thick cream is obtained within 40-60 minutes. After that the masonry solution is ready for use within 3 days. If it thickens, then by adding a small amount of water with stirring it is brought into a working state.

Prepared masonry SHS solution is used when laying bricks in the furnace lining. The folded lining is first dried naturally. Then the heating of the furnace starts according to the standard mode. When the temperature reaches 800-950 °C, self-ignition and burning of the dried masonry mortar takes place with the synthesis of refractory material, which welds the brickwork into a monolith. Since the linear rate of synthesis is equal to 2-3 mm / s, the liner collects the necessary parameters within 1-5 minutes. The obtained lining has high heat resistance, slag resistance, thermal insulation properties and extended service life of 1.4-3 times.

These refractories are relatively inexpensive and can be produced in large quantities, since their production is based on the use of mineral raw materials (chromite ore, dolomite, magnesite) and industrial waste (blast-furnace and refractory production, scale, etc.).

SHS refractories of "Furnon" brand (originally they were labeled "Termok") can be used as:

- masonry mortars (welding compounds) for highly refractory and fireclay articles;

- fireproof coatings.

The manufacture and use of such a masonry mortar was described in 2.3.2., And the properties of refractory concrete "Furnon-1" - in 4.3.1. In general, all refractory SHS-materials of the Fournon family are presented in Table. 5.14.

Table 5.14

Properties and application of SHS-refractories "Furnon"

Refractory material	Thermo-mechanical properties		Application area	Implemented
	Refractoriness, °C	$\sigma_{сж.}$, MPa		
Furnon-1	1850	80-100	Stuffing mass	Lining of combustion chambers, arches and arches of electric arc furnaces
Furnon-2	1830	20	Cover	Lining of a dust-coal nozzle
Furnon-3	1800	50	Welding composition	Zones outside contact with steel in metallurgy, cement kilns, etc.
Furnon-4	1800	45	Beton	Lining of dampers, thresholds, weltz-furnaces, etc.
Furnon-5	2000	35	Welding composition	ones of contact with steel in furnaces, steel drain gutters, ladle, working space of open-hearth furnaces
Furnon-6	2100	35	—" —</td <td>—"<!--—</td--> </td>	—" —</td
Furnon-7	1700	40	Welding composition	For chamotte bricks
Furnon-8	2100	20	Lightweight brick	Heat and electrical insulation

These refractory materials were tested on industrial furnaces of a number of enterprises and produced a positive effect (see Table 5.15, where the economic effect is indicated in 1988 prices).

Refractories "Furnon-1, 2, 3, 4" are developed on a chromite basis and are designed to work as refractory concrete, ramming mass, masonry mortar.

Refractory concrete "Furnon" is promising for reducing the consumption of highly refractory bricks and products. This is possible due to the high strength and high thermal insulation properties of these SHS materials. However, for this purpose it is necessary to organize the production of such concretes. It is much easier to organize the production of masonry mortar (see section 2.3.2). Therefore, the masonry (welding) solution "Fournon-3" is more promising for use. He, when laying lining, gives construction strength, and after combustion (synthesis) he welds bricks into a monolith. Thus, a significant hardening of the refractory structure (up to 10-15 MPa at 1300-1700°C) is achieved and its service life is increased by 1.8-2.0 times. 1 ton of SHS-refractory preserves 10-20 tons of high-quality refractory bricks.

Table 15. Results of the pilot-industrial introduction of SHS refractories

Mark of refractory	Place of industrial tests	Service life with traditional technology	Service life using SHS technology	Longer service life, %	Economic effect
Furnon-1	Alma-Ata Heavy Engineering Plant	30-34 days	The stability of the arch increased by 1.5 times, the stability of the arch and the columns of the working window - 2 times	50-100%	The preliminary 30 thousand rubles..
Furnon-2	Karagandacement	12-15 days	Lining of the pulverized-coal nozzle 60-64 days	4 times	Fact. annual savings of 384 thousand rubles.
Furnon-3	Karmetkombinat Karagandacement	160 days Ø3,6 m 60 days Ø7 m	346 days 120 days	Sintering zone 2 times	3 million rubles are expected.
Furnon-4	Karmetkombinat	4-5 days (flap)	18-21 days	3-4 times	Fact. in 1987, 55 thousand rubles.
Furnon-5	Karmetkombinat	80-100 melt	220-240 days	2 times	It is expected in 1988, 8090 thousand rubles.
Furnon-6	Karmetkombinat	Bucket (10-12 melt)	14 melt	25-30%	Not rated

However, the refractory materials "Furnon" on a chromite base were not universal in use, for example, in a molten steel and slag environment they have a low resistance. Specially for contact zones with slag melt and steel, "Furnon-5" and "Furnon-6", respectively, on the dolomite and magnesite base were developed. These materials are tested on gutters, sections of open-hearth furnaces. Their use for fireclay masonry with steel-buckets of 5 tons increased the service life of the liner by 40%, and steel-bucket capacity of 300 tons - by 20-30%. It is shown that the resistance of the lining of steel-ladles is limited not by the stability of the seam, but by the bricks. Therefore, the overall resistance of the refractory structure increases significantly if the "Furnon-5" and "Furnon-6" formulations are used as the shotmass. Gunningof walls are promising not only for steel-ladles, but also for open-hearth furnaces and converters.

Refractory "FURNON"

Refractory "FURNON" elaborated by the Combustion Problems Institute as a dry mix for masonry mortar by using of SHS-technologies.

Application of "FURNON" materials makes the lining more strength cause of "welding" of bricks in the SHS-process by exit of aggregate to work temperature regime.

СНИИТЭЗ (СБС).

The infographic features a logo in the top left corner, a central title box, a photograph of glowing masonry bricks, a circular cross-section of a refractory component, and a large cross-sectional diagram of a furnace or ladle showing a molten metal core surrounded by a refractory lining.

Figure 50 - "Furnon", created at the Institute of Combustion Problems

Note the high-temperature refractory lightweight "Fournon-8" with a density of 800-1500 kg/m³, an open porosity of 56-88%, a compressive strength of 2.8-4.0 MPa and a thermal conductivity factor of 2-2.6 W / m × K . It can be used as a liner for thermal units with an operating temperature up to 2300°C in the presence of an aggressive medium, and also as a high-refractory thermal insulation material in aerospace engineering. The SHS process makes it possible to obtain such refractory in the form of light blocks-heat insulators in one stage, immediately at the location. Compared to refractory refractory bricks, traditionally obtained as a result of a long process of annealing, compacting and sintering, SHS blocks are much cheaper at higher performance characteristics.



a)

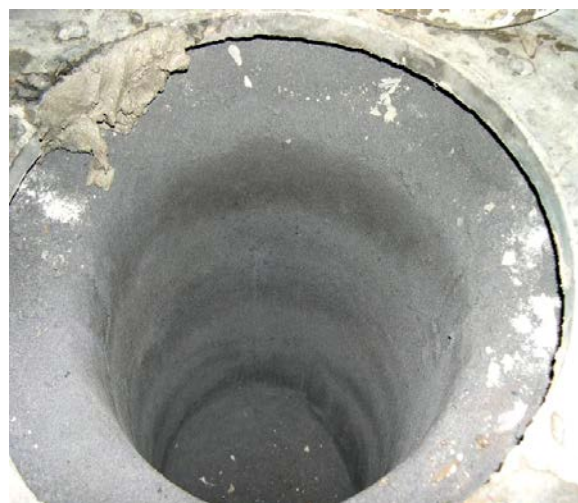

b)

Figure 51- Lining of induction furnace IST-016

11 PROSPECTS OF DEVELOPMENT OF SHS-TECHNOLOGIES

11.1 Organic Self-Propagating High-Temperature Synthesis

Organic self-propagating high-temperature synthesis (organic SHS, OSHS; Eng. Organic self-propagating high temperature synthesis, OSHS) - autowave mode of exothermic organic synthesis in solid-phase dispersed (powdered) mixed mixtures containing organic compounds. Formally, it refers to solid-phase combustion. Studies of organic SHS (OSHS) that have lasted for several years have caused the understandable need for awareness and formulation of its concept. The year of its foundation is, apparently, 1986, when, under the impression of a

thorough review by A.G. Merzhanov, the author purposefully conducted a search for examples of organic reactions that could be organized in the OSHS mode. The same period of time includes the receipt of the first author's certificate on OSHS from the VNII GGE Institute (Institute for State Patent Examination).

Confidence in the success of the search was reinforced by the realization that the theory of SHS does not impose any restrictions on the nature of reagents and products, and the already established scientific ideology of SHS can significantly speed up the resolution of OSHS problems.

OSHS is realized after local initiation (usually - point heating) of the exothermic reaction in any part of the mixture. Further, according to the laws of combustion, the focus of the reaction increases, spreading to the rest of the mixture and covering it entirely. The formation of the target product, the establishment of its final phase and chemical composition is completed during or after cooling the mixture.

It is used for the synthesis of condensed useful organic substances of different classes, the creation of materials and products, as well as in technical devices and processes. It is an object of study of the chemistry of an organic solid. Proposed in 1986; first publicly reported in 1988; as an independent term first used in. Published a brief overview, the concept of direction and development prospects, information about OSHS included in the encyclopedia.

Historically arose and methodologically appears as the application of the well-known method of self-propagating high-temperature synthesis (SHS) of inorganic products in order to obtain precisely organic substances.

They mainly differ from SHS processes in inorganic systems by relatively low maximum temperatures in the synthesis wave front (70–250 ° C, versus 2600-4100 ° C). The reason for this is the predominance of molecular crystals with a relatively low binding energy in solid organic substances.

Therefore, OSHS processes are not accompanied by luminescence and are observed in reflected light. This made it possible for the first time to involve such physicochemical methods for in situ studies of exothermic wave processes studies like EPR, computational IR thermography, optical spectroscopy in diffuse-scattered light, etc., significantly simplified the technological equipment and experimental technique, facilitated physical and mathematical modeling.

Among other features of OSHS, it should be noted a wider range of dispersion of powders (due to larger fractions), lower temperatures and heats of initiation, low thermal effects and activation energies.

Unlike pyrotechnic processes, they belong to low-energy systems, and, as a

rule, are not accompanied by thermolysis and significant gas evolution, therefore they result in useful condensed organic products of different chemical nature.

In comparison with the known methods of sintering, they do not need bulky furnaces, thermostatic and mixing devices, being an energy-saving method.

From traditional methods of organic synthesis they differ completely or partially with the exclusion of solvents from technological schemes (“dry synthesis”), as well as simplicity and speed (“click-synthesis”). Therefore, OSHS products are usually cleaner because they do not contain traces of solvent and by-products due to its presence, and the technologies are less toxic and explosive and flammable.

These features ultimately determine the cheapness of synthesis products, the environmental preference and safety of the method, and allow us to recommend it as an effective way of organic synthesis, including under extreme conditions, when solvents are either not available or undesirable (space and polar stations, etc.)

The OSVS mechanism has a number of distinctive features, due to both the nature of organic solids and their reactions, and the physicochemical characteristics of the process itself.

In the majority of the systems studied, the OSMC macromechanism includes the following stages: 1. a slight (~ 5%) reaction of the mixed powders along the contact surface of the particles at room temperature; 2. melting of the low-melting component in the zone of initiation of the reaction, then performing the role of a heated solvent; 3. capillary spreading of the melt in a porous spatial matrix formed by particles of a refractory reagent; . exothermic chemical interaction, accompanied by phase transitions of both reactants and reaction products; . the formation of the microstructure of solid-phase reaction products; the formation of the macrostructure of the entire mass of the reacted sample.

The process of OSVS is accompanied by radiation of acoustic waves (acoustic emission) carrying information about the motion of the reaction medium (formation of cracks, pores, bubbles, etc.) and, therefore, the structure of the final product, which is the basis of the acoustic method of studying the mechanism of OSHS and its products.

The mechanism of mass transfer of reagents for OSHS is different at different stages of the reaction and in different parts of the reaction mixture. In regions with a temperature below the melting point of the reactants, solid and gas phase diffusion prevails; at the melting point and above - liquid phase.

Molecular mechanisms in OSHS differ a great variety characteristic of organic reactions. Thus, mechanisms unknown in inorganic systems were observed, for

example, proton transfer (acid-base reaction), radical substitution (halogenation), electrophilic substitution (Friedel-Crafts Reaction), etc.

OSWS products include both low molecular weight compounds of various chemical classes (organic salts, hydroxy and halogen derivatives, etc.), and polymers. In the latter case, the term “frontal polymerization” was historically entrenched for such processes, originally applied to liquid-phase systems closer to the Belousov periodic reaction.

Organic products of piperazine (anthelmintics), ortho-carboxybenzoylferrocene and its salts (the drug "ferroceron" used for iron deficiency anemia), halogen derivatives of carboxylic acids (mono- and dibromomalonic acid), and The list of these products is replenished.

OSHS products usually have greater purity in comparison with substances obtained by the methods of traditional organic chemistry, because in the methods of synthesis solvents are not used or are limited. Therefore, as undesirable impurities are not contained as solvents and by-products formed from them or with their participation. In addition, when OSHS also manifests the effect of self-cleaning of the product OSHS due to thermal desorption of volatile impurities during synthesis.

Special conditions of heat and mass transfer during OSHS lead to the production of products with a unique microstructure, which is especially important in the synthesis of solid-phase drugs, for which the structure-property relationship is important. SHS systems are traditionally used as a working fluid in autonomous sources of heat (chemical stove). Organic systems cover the low-temperature range (70-300 °C).

As a technological method, it can be used for painting and texturing the surface of various polymers.

In some cases, OSVS implements the mode of natural radial shrinkage of products, which creates the possibility of obtaining hollow composites and products from organic materials (pipes, glasses, etc.) in one technological stage without the use of special forming devices.

It was shown that if the reagents that satisfy the a priori formulated criteria — solid phase, exothermic interaction, thermal stability of products — prepare a stoichiometric mixture, then, just by analogy with the SHS method, compact it, bring a small local heat pulse to it, then an exothermic synthesis wave occurs, by passing which in a mixture with a good yield, valuable organic substances are determined. The latter circumstance of OSHS favorably differs from the long-

known processes of combustion and decomposition of organic mixtures, which are studied in detail by the science of pyrotechnics.

The precedent of OSHS was created by the example of the synthesis of quingidron and quinone by the oxidation of hydroquinone with an inorganic oxidizing agent, potassium bromate. The latter, later, for the “purity of the experiment”, was replaced by an organic oxidizing agent - chloramine B. A further search for examples of OSHS was carried out in such traditionally exothermic classes of organic reactions as oxidation, halogenation, protonation, etc. autowave modes in ~ 40 cases, more than 10 systems are investigated in detail. Among the synthesized substances, were halogencarboxylic acids, substituted 8-hydroxyquinoline, triphenylphosphine derivatives, etc.

The search for understanding among professional organic chemists led to the study of systems prompted by interested co-authors. So among the useful products OSHS was o-carboxybenzoylferrocene, which is used under the trade name "ferroceron" as a medicine for the treatment of iron deficiency in the human body. Another example, the synthesis of triphenyl-N- (phenylsulfonyl) phosphinimine, showed the potential use of OSHS for herbicides.

One example - the synthesis of piperazine malonate - was chosen as a model, since it was a one-step addition reaction that proceeded completely without the formation of by-products. He was most fully investigated in all its aspects.

Summing up, it can be argued that a new scientific direction has begun - organic SHS, which has good prospects of both applied and fundamental nature. To achieve them, it is necessary to expand the experimental data base by searching for and researching new organic systems in which the SHS mode is possible.

11.2 Solution combustion

Combustion of reaction media created by dissolving the initial solid-phase chemical components in liquid media, the so-called solution burning (GH) or Solution combustion, is a new method for the synthesis of nanomaterials. The composition of the solutions is determined in accordance with the basic principle of self-propagating high-temperature synthesis (SHS), namely: the amount of heat released during the process should be sufficient for self-sustaining propagation of a chemical reaction. The main difference between GR and the “classical” SHS is determined by the microstructure of the initial reaction medium. Its advantage is: the ability to mix reagents at the molecular level (in conventional SHS systems, the size of solid-phase particles is 1–100 μm .); no sintering of crystallites of the solid phase, due to the presence of a large amount of gaseous products; short duration and low temperature synthesis, due to the presence of components that provide the necessary amount of energy sufficient for self-sustaining propagation of a chemical reaction. This facilitates the task of synthesizing nanomaterials at high

temperatures of the combustion wave. Despite the fact that a large number of compounds (mainly oxides) have already been synthesized by the GH method, the combustion mechanism, the structure of the reaction wave, and the dynamics of phase formation in this process have been little studied. In systems where the only solid-phase reaction product is metal oxide, the presence of a large amount of gaseous products formed from the solution prevents sintering of the crystalline solid phase. These features allowed the GH method to synthesize a very large number of different oxides with high specific surface and nanoscale particles. Recently, studies have appeared in which the GR method is proposed for the production of pure metals, which makes it possible to significantly expand the range of products of combustion of solutions.

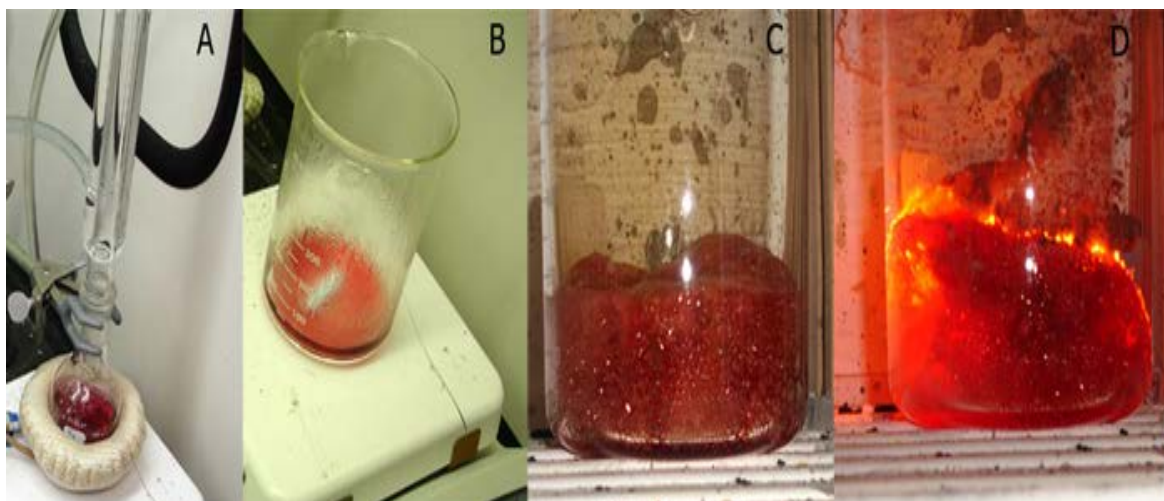
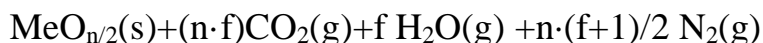

Figure 52 $-Me^n(NO_3)_n + (n \cdot f) CH_2NH_2CO_2H + n \cdot (f-1) O_2 \Rightarrow$



Now scientists are actively exploring an alternative way to synthesize nanomaterials — self-propagating high-temperature synthesis (CBC) in solutions, or “burning solutions”. The process is based on a self-sustaining exothermic (that is, heat generation, burning) reaction of the interaction of components based on systems containing an oxidizing agent (metal nitrate) and a reducing agent (water-soluble linear and cyclic organic amines, acids and amino acids). The chemical reaction is extensively distributed in the solution. As it fades away, final products are formed. In solutions, the initial reagents are mixed at the molecular level, and the release of a large amount of gases during the

interaction of reagents in the combustion wave facilitates the formation of nanopowders.

The processes of combustion and synthesis of materials have long been the object of close attention of scientists. In the XIX century, the Russian physicist and chemist Nikolai Beketov found that if you mix some metal oxides with aluminum and heat the mixture in a furnace, a chemical reaction will occur, resulting in the production of pure metal. In 1898, German metallurgical engineer Hans Goldschmidt invented an industrial method of smelting metals from their oxides using aluminum as a reducing agent. At the beginning of the 20th century, his method began to be used for welding rail rails, and later found application in the military industry. ” Since the 1980, this area has been actively developed in many countries. In the 1990s, a new type of SHS process was discovered in India - self-propagating high-temperature synthesis in solutions. Having studied the work of Soviet scientists, the group under the leadership of Professor Kashinath Patila began to mix soluble components in an aqueous solution. They took metal nitrate as a basis, added organic fuel (glycine, sucrose, citric acid or urea) and started the reaction. Scientists have investigated a huge amount of combustion products; now, to obtain nanofirm with homogeneous particles, they add extracts from tropical plants to the initial mixture of nitrates. Today, scientific groups studying SAF in solutions exist in more than 70 countries (USA, China, South American countries, Arab countries, etc.). But the mechanism of formation of the final products in the combustion front is still poorly studied.

In Russia, the palm of excellence in the study of the mechanisms of the "burning in solutions" process belongs to scientists from the National Research Technological University "MISiS". The research team, under the leadership of Professor Alexander Mukasyan, studies the temperature and time characteristics of the combustion process of solutions, the effect of the fuel-oxidizer ratio, the organization of the process in the form of a propagating wave, separation into the wave mode and the volume combustion mode and other parameters. In September 2016, a team of scientists published a review of research in this area in the journal Chemical Reviews.

Researchers have already achieved impressive results. By placing a mixture of nickel nitrate and glycine in a highly porous medium, and starting the reaction, they obtained a catalyst that does not degrade or become polluted in the process, and therefore functions ten times longer than conventional catalysts. The reaction

accelerator has been working intensively for several years now, so scientists even jokingly call it “eternal”. The method for producing a superstable catalyst is already patented.

"Burning solutions" opens up opportunities for the development of modern energy. The resulting nanoporous materials are used in new types of fuel cells, solar cells, supercapacitors and batteries, as well as in thermoelectrics (used to directly convert heat into electricity). They are in demand in hydrogen energy, for example, to convert hydrocarbons to methane or to obtain pure hydrogen from ethanol, and can be used as phosphors - substances that can convert the energy absorbed by them into light radiation.

Nanomaterials — structures with a characteristic size from 1 to 100 nanometers (10⁻⁹–10⁻⁷ m) - exist as particles, porous structures, tubes, fibers, dispersions (intermediate systems between solutions and suspensions), structured surfaces, films, and also crystals and clusters. Due to its unique functional properties, nanomaterials are in demand in a wide variety of industries: instrument-making and electronics, medicine and pharmaceuticals, construction, the military-industrial complex, agriculture, etc.

Today, the study of the SHS process in solutions is only gaining momentum. Scientists are continuing to study the mechanisms underlying the process, and perhaps soon they will receive materials with unusual properties that will open up new possibilities for humanity.

Combustion of reaction media created by the dissolution of the initial solid-phase chemical components in liquid media, the so-called solution burning (GR), is a new method for the synthesis of nanomaterials. The composition of the solutions is determined in accordance with the basic principle of self-propagating high-temperature synthesis (SHS), namely: the amount of heat released during the process should be sufficient for self-sustaining propagation of a chemical reaction. The main difference between GR and the “classical” SHS is determined by the microstructure of the initial reaction medium. Its advantage is: the ability to mix reagents at the molecular level (in conventional SHS systems, the size of solid-phase particles is 1–100 μm,); no sintering of crystallites of the solid phase, due to the presence of a large amount of gaseous products; short duration and low temperature synthesis, due to the presence of components that provide the necessary amount of energy sufficient for self-sustaining propagation of a chemical reaction. This facilitates the task of synthesizing nanomaterials at high temperatures of the combustion wave. Despite the fact that the Solution combustion method has already synthesized a large number of compounds (mainly oxides), the combustion mechanism, the structure of the reaction wave, and the dynamics of phase formation in this process are little studied.

In systems where the only solid-phase reaction product is a metal oxide, the presence of a large amount of gaseous products formed from the solution prevents sintering of the crystallites of the solid phase. These features allowed the method of CS to synthesize a very large number of different oxides with high specific surface and nano-sized particles. Recently, studies have appeared in which the CS method is proposed for the production of pure metals, which makes it possible to significantly expand the spectrum of the combustion products of solutions. "Burning solutions" opens up opportunities for the development of modern energy. The resulting nanoporous materials are used in new types of fuel cells, solar cells, supercapacitors and batteries, as well as in thermoelectrics (used to directly convert heat into electricity). They are in demand in hydrogen energy, for example, to convert hydrocarbons to methane or to obtain pure hydrogen from ethanol, and can be used as phosphors - substances that can convert the energy absorbed by them into light radiation. Solution combustion synthesis (SCS) is a versatile, simple and rapid process, which allows effective synthesis of a variety of nanosize materials. This process involves a self-sustained reaction in homogeneous solution of different oxidizers (e.g., metal nitrates) and fuels (e.g., urea, glycine, hydrazides). Depending on the type of the precursors, as well as on conditions used for the process organization, the SCS may occur as either volume or layer-by-layer propagating combustion modes. This process not only yields nanosize oxide materials but also allows uniform (homogeneous) doping of trace amounts of rare-earth impurity ions in a single step.

Researches and technological developments carried out in recent years by scientists in the field of SHS laid the foundations of a modern and promising scientific and technical field, which has its own structure, research areas and applications. The purposeful search for new SHS systems, the study of the mechanism and laws of their combustion and synthesis conditions constitute the prospect of the development of the SHS method and the development of new efficient technological processes. Perspectives of SHS will be determined by the following directions:

1. Structural macrokinetics, regulation of the structures of SHS-products.
2. Multidimensional modeling of combustion processes.
3. Gas-phase and gas-dispersed SHS. Interest in this kind of process is itself associated with the possibility of organizing continuous SHS production using gas burners, cyclone furnaces and other devices with heat recovery.
4. SHS in organic systems.
5. Non-traditional powders. It was found that using the SHS method it is possible to obtain polycrystalline products with nanoscale crystallites and to realize their qualitatively new properties.

6. Nonequilibrium, the so-called functionally gradient materials.
7. One-step production of products of a given shape. In SHS processes, all prerequisites are realized for directly obtaining useful products of a given shape and size from combustion products: a refractory material is synthesized quickly (about a minute) and with such internal heat release (and not external heating) that under the influence of external pressure the material is transferred to a plastic state. This allows you to get the finished product at once in one stage and in one installation.
8. Continuous production and large-scale production. Continuous SHS technology is still a problem of the future.
9. Mechanochemistry of SHS.
10. Experiments in space, the effects of microgravity.

Over the 50 years of the discovery of solid flame and SHS processes, this branch of science continues to evolve at a rapid pace. Creating a technology of SVS, the development of its theory is the greatest achievement of Soviet and Russian science. The pioneering and leading role of the modern Russian school of the CBC is generally recognized abroad.

LIST OF USED SOURCES

1. Левашов Е.А., Рогачев А.С., Курбаткина В.В., Максимов Ю.М., Юхвид В.И. Перспективные материалы и технологии самораспространяющегося высокотемпературного синтеза. – М.: МИССИС, 2011. – 377 с.
2. Мержанов А.Г., Мукасян А.С. Твердопламенное горение. – М.: ТОРУС ПРЕСС, 2007. - 336 с.
3. Коллективная монография под ред. З.А.Мансурова «СВС-композиционные материалы».-Алматы, Қазақ университеті, 2015- 330с.
4. Тавадзе Г.Ф., Штейнберг А.С. Получение специальных материалов методами самораспространяющегося высокотемпературного синтеза. – Тбилиси, 2011. – 206 с.
5. Рогачев А.С., Мукасян А.С. Горение для синтеза материалов: Введение в структурную макрокинетику.- М.:ФИЗМАТЛИТ- 2012 -400с.
6. А.П. Амосов, И.П.Боровинская, А.Г.Мержанов //Порошковая технология самораспространяющегося высокотемпературного синтеза материалов.- М.,2007,567с.

7. Merzhanov A.G., Borovinskaya I.P. Historical Retrospective of SHS: An Autoreview // International Journal of Self-Propagating High-Temperature Synthesis. – 2008. – Vol. 17. – P. 242-265. (English)

8. Pradeep Sherikar Koli " Effect Of Fuel To Oxidizer Ratio (F/O) On YFeO₃ Phase Formation Using Glycine Fuel During Solution Combustion Process" International Journal of Engineering Research And Management (IJERM), Volume-03 Issue-07, July 2016, 2349- 2058

9. Абдулкаримова Р.Г. Процессы самораспространяющегося высокотемпературного синтеза Алматы: «Казак университеті», 2017.- 137с.

10. Varma, A. Mukasyan, A. Rogachev, K. Manukyan, Solution Combustion Synthesis of Nanoscale Materials, Chemical Reviews, 2016, 116, 23, 14493–14586.

11. С. И. Росляков, Д. Ю. Ковалев, А. С. Рогачев, Х. Манукян, А. С. Мукасян Горение растворов: Динамика фазообразования при синтезе высокопористого никеля Доклады Академии Наук, 2013, т. 449, N. 3, с. 313–316