



20<sup>th</sup> International Congress of Chemical and Process Engineering CHISA 2012  
25 – 29 August 2012, Prague, Czech Republic

## Numerical research of aerodynamic characteristics of combustion chamber BKZ-75 mining thermal power station

A. S. Askarova, S. A. Bolegenova, V. Yu. Maksimov <sup>a</sup>\*, A. Bekmuhamet,  
Sh. S. Ospanova

*Al-Farabi Kazakh National University Department of Physical and Technical,  
Almaty, ave. 71 Al-Farabi, 050040, Kazakhstan*

---

### Abstract

There were researched processes of heat mass transfer by burning of pulverized coal on the sample of combustion chamber BKZ-75 of Shahtinsk TPS by using of 3D Modeling technologies on the basis of differential equation solution of turbulent reacting flows. Got distribution of vector components of full speed in different sections of combustion chamber, given dependence of velocity vector to the height of combustion chamber, temperature profiles and its distribution on the height of combustion chamber are obtained. Set minimum and maximum values of given variables, shown dynamics of changing of given characteristics in the volume of investigated combustion chamber.

© 2012 Published by Elsevier Ltd. Selection under responsibility of the Congress Scientific Committee (Petr Kluson)

*Keywords:* Numerical modeling; combustion; combustion chamber; thermal performance; reacting mixture; pulverized coal

---

### 1. Introduction

The study of convective heat problems in turbulent flows in the presence of chemical reactions is an important task of thermo physics and hydrodynamics; as such, flows are widespread in nature and play an important role in many technical devices. Knowledge of the laws of such flows is important in constructing a theory of physics of combustion, creating a new physical-chemical technology, as well as problem-solving power engineering and ecology. In studies of complex combustion process should be analyzed depending on the influence of numerous physical and chemical parameters of the combustion

---

\* Corresponding author. Tel.: +7-727-377-34-02; fax: +7-727-377-34-01.

E-mail address: [maximov.v@mail.ru](mailto:maximov.v@mail.ru)

reaction. The development of the theory of heat and mass transfer, development on this basis, manufacturing processes and systems with the rational use of energy resources is an actual task.

A strict theory of turbulent reacting multiphase flows is not currently available due to the large number of interrelated processes that must be considered when creating mathematical models.

The main tool of theoretical studies of nonlinear processes of heat mass transfer in moving media, taking into account a variety of physical phenomena (such as turbulence, radiative heat transfer, combustion, multiphase, external forces, etc.) is mathematical modeling and computational experiment. They include not only the development of numerical methods and numerical calculations, but in-depth analysis of the model, its adequacy to the real process. Computer simulation is largely replacing costly and time-consuming experimental studies [1].

Application of 3D-modeling technology along with the latest computer technology with high accuracy to carry out a theoretical study of nonlinear physical processes of heat mass transfer of the medium taking into account a variety of physicochemical phenomenon such as radiative heat transfer, combustion, increased levels of turbulence. In the study of a wide range of modern problems of science and engineering modeling of heat mass transfer processes is of particular importance and has wide practical application [2].

Among the methods of modeling the combustion of pulverized fuel most widely used method, based on the Euler an approach to describe the motion and heat transfer of the gas phase. This method uses the spatial balance equations for mass, momentum, the concentrations of gaseous components and energies for the gas mixture. To describe the motion of single particles along their trajectories Lagrange approach using [3]. Turbulent flow structure is described by a two-parameter of  $k - \epsilon$  model of turbulence, where  $k$  - the kinetic energy of turbulence,  $\epsilon$  - turbulent energy dissipation.

**2. Mathematical model**

The mathematical description of physical and chemical processes based on the solution of balance equations. In general, these equations contain four terms that describing:

- change in the value of time;
- convective transfer;
- diffusive transfer;
- Source or sink.

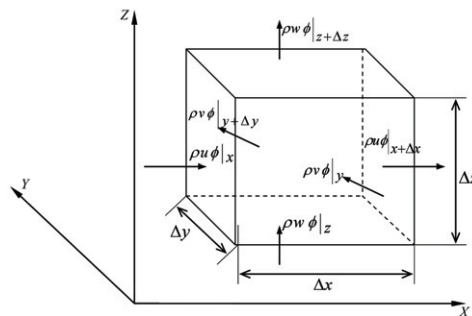

Fig. 1. Control volume for the generalized transport equation [4], where  $\rho u \phi |_{i,i \Delta i}$  – describes the convective transfer across the borders of the variable control volume in Cartesian coordinates.

For derive the balanced ratios selected stationary control volume element or control element of mass. It is supposed that the center of gravity of the selected element moves with the velocity of flow. This corresponds to a stationary control volume sound approach for the Euler flow. Change the

value of the transport is described in a single fluid element. The value of this quantity is determined at each point of the domain.

By converting from a finite limit to the infinitesimal volume element is obtained by controlling the differential equation describing the conservation of the transport variable :

$$\begin{aligned} \frac{\partial(\rho\phi)}{\partial t} = & -\frac{\partial(\rho u_1\phi)}{\partial x_1} - \frac{\partial(\rho u_2\phi)}{\partial x_2} - \frac{\partial(\rho u_3\phi)}{\partial x_3} + \frac{\partial}{\partial x_1} \left[ \epsilon_{\Gamma} \phi \frac{\partial\phi}{\partial x_1} \right] + \\ & + \frac{\partial}{\partial x_2} \left[ \epsilon_{\Gamma} \phi \frac{\partial\phi}{\partial x_2} \right] + \frac{\partial}{\partial x_3} \left[ \epsilon_{\Gamma} \phi \frac{\partial\phi}{\partial x_3} \right] + S_{\phi}, \end{aligned} \quad (1)$$

where  $\rho$  – density;  $u_i$  – flow speed in the direction  $x, y, z$ ;  $\phi$  – variable transfer,  $\Gamma$  – diffusion coefficient.

Changing in equation (1) the convective and diffusive transfer of flux density, cross-border control volume, we obtain a flux density:

$$\Phi_{(K),j} = \rho u_j \phi - \text{Convective component};$$

$$\Phi_{(D),j} = \Gamma_{\phi} \frac{\partial\phi}{\partial x_j} - \text{Diffusive component.}$$

Taking into account equation (1) written as:

$$\frac{\partial(\rho\phi)}{\partial t} = -\frac{\partial\Phi_{(K),j}}{\partial x_j} + \frac{\partial\Phi_{(D),j}}{\partial x_j} + S_{\phi}. \quad (2)$$

We write Eq. (2) in vector form:

$$\frac{\partial(\rho\phi)}{\partial t} = \text{div} \left( (-\rho u\phi) + \Gamma_{\phi} \text{grad}\phi \right) + S_{\phi},$$

and in tensor form, equation (2) takes the form:

$$\frac{\partial(\rho\phi)}{\partial t} = -\frac{\partial(\rho u_j\phi)}{\partial x_j} + \frac{\partial}{\partial x_j} \left[ \epsilon_{\Gamma} \phi \frac{\partial\phi}{\partial x_j} \right] + S_{\phi}. \quad (3)$$

In the future to calculate the gas flow - solid-phase with the input of all transport quantities in the control volume are determined by the generalized equation (3). In this equation  $S_{\phi}$  – source (sink) term for the quantity, other terms describes the variation of :

$$\frac{\partial(\rho\phi)}{\partial t} - \text{Time component};$$

$$\frac{\partial (\rho u_j \phi)}{\partial x_j} - \text{Convective transfer};$$

$$\frac{\partial}{\partial x_j} \left[ \rho \Gamma_\phi \frac{\partial \phi}{\partial x_j} \right] - \text{Molecular transfer}.$$

In a mathematical model of gas, flow or liquids are the equations of conservation of mass and momentum. For flows in which there are processes of heat transfer, as well as for compressible media to solve the equation of energy conservation. In flows with the processes of mixing of different components, with the reactions of combustion, etc. must be added the equation of conservation of the mixture components or the conservation equation for mixture fraction and its changes. For turbulent flow the system of equations is complemented by transport equations for turbulent characteristics

Thus, to solve this problem we consider the equations describing the flow and which are derived from the generalized equation (3). This system has no analytical solution and can only be solved by numerical methods.

In general, for numerical solution of the whole computational domain is divided into discrete difference grid point, or volume, continuous field variables is replaced by discrete values at the nodes of the grid, and derivatives in the differential equations are replaced by their approximate expressions in terms of the difference of function values at grid points. In the present study for the problem is solved using the method of control volume. The system of algebraic equations for the differential equation of control volume for each balanced value is as follows:

$$a_p \phi_p = \sum_n a_n \phi_n + S_\phi \quad (4)$$

Determine coefficients the contribution of convective and diffusive flow in all directions at each point of control volume. In result of the approximation of equation (2) obtained an algebraic equation (3) for each control volume and for each unknown variable  $\phi_n$ . For each cell in the computational domain used physical laws of conservation and differential equations describing these laws (transfer equation), integrated over the volume of each cell.

### 3. The results of computer experiment

For getting the temperature and the aerodynamic characteristics in the combustion chamber BKZ-75 Shahtinsk TPS (Kazakhstan), a numerical study of heat and mass transfer processes occurring during combustion of low-grade coal injection grade KR-200. In the study used 3D modeling technology based on the solution of differential equations of turbulent reacting flows.

Profiles of vector components of velocity in the full cross section of the burners in the longitudinal section of the combustion chamber are obtained. Shown is the dependence of the vector full speed adjustment of the combustion chamber. In these sections temperature profiles obtained and the dependence of the flow temperature depending on the height of the combustion chamber.

The boiler BKZ-75 Shahtinsk TPS, equipped with four pulverized coal burners installed on two burners from front and rear in one layer. The boiler burns ordinary dust of Karaganda (KR-200) coal, ash content 35.1%, a volatile 22%, 10.6% moisture and heat of combustion of 18,550 kJ / kg. Initial data for calculation are shown in the table.

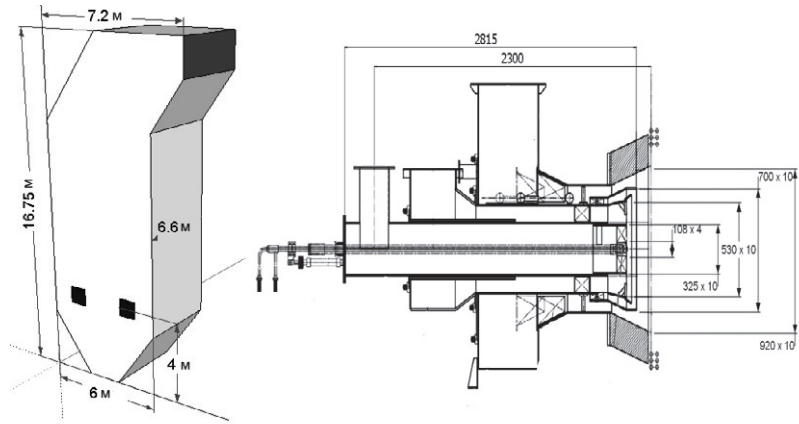

Fig. 2. The general form of the combustion chamber and coal-dust burner

Table 1. Initial data

Name	Description	Unit	Numerical value
Type of coal	KR-200	-	-
Dry basis ash	$A^c$	%	35,1
Volatile fuel mass	$V^r$	%	22
Operating humidity	$W^p$	%	10,6
Combustion heat	$Q_{H}^p$	Cal/kg	4433
Number of burners in the boiler	$N_r$	Pcs.	4
One fuel burner productiveness	$B_r$	t/h	3,2
Consumption of primary air to the boiler	$V_{p.a.}$	kg/h	28233
Secondary air flow to the boiler	$V_{s.a.}$	kg/h	78163
Hot air temperature	$T_h$	°C	290
Hydrodynamic resistance of the burner fuel mixture channel	$\Delta P$	-	67,1
Furnace suction	$\Delta \alpha$	-	30,4
The coefficient of excess air beyond the fire	$\alpha_e$	-	2,019
Mechanical fuel under burning	$Q_4$	%	13,37
Boiler efficiency, the gross	$\eta_k$	%	80,88
Fuel consumption for the boiler	$B$	t/h	12,49
Coal density	$\rho$	kg/m <sup>3</sup>	1300
Carbon	C	%	43,21
Hydrogen	H <sub>2</sub>	%	3,60
Oxygen	O <sub>2</sub>	%	5,24
Sulfur	S <sub>2</sub>	%	1,04
Nitrogen	N <sub>2</sub>	%	1,21
Water	H <sub>2</sub> O	%	10,60
Ashes	-	%	35,10

The computer area for numerical experiments and the creation of a database for simulation is carried out in several stages with the use of software systems [5]. These computer software packages allow you to perform complex computational simulations of reacting multiphase flows in the areas of real geometry. By creating a geometric model of each wall of the combustion chamber is described separately in the form of numerical codes.

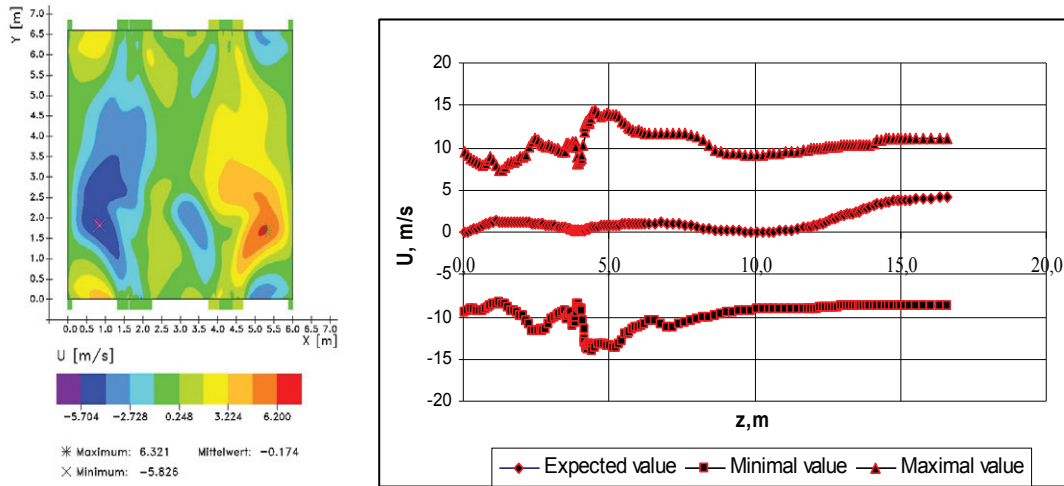

Fig. 3. The distribution of the velocity component U in the burner section on the height of the combustion chamber

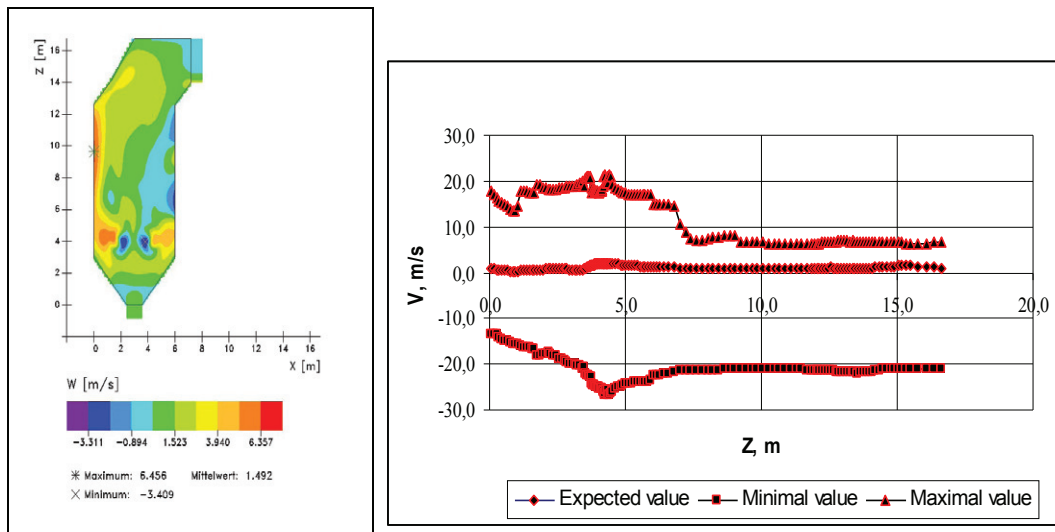

Fig. 4. The distribution component of the velocity V in longitudinal section and the height of the combustion chamber

These figures illustrate the picture of the velocity distribution in the furnace space through which can be characterized the behavior of pulverized coal flow inside the combustion chamber.

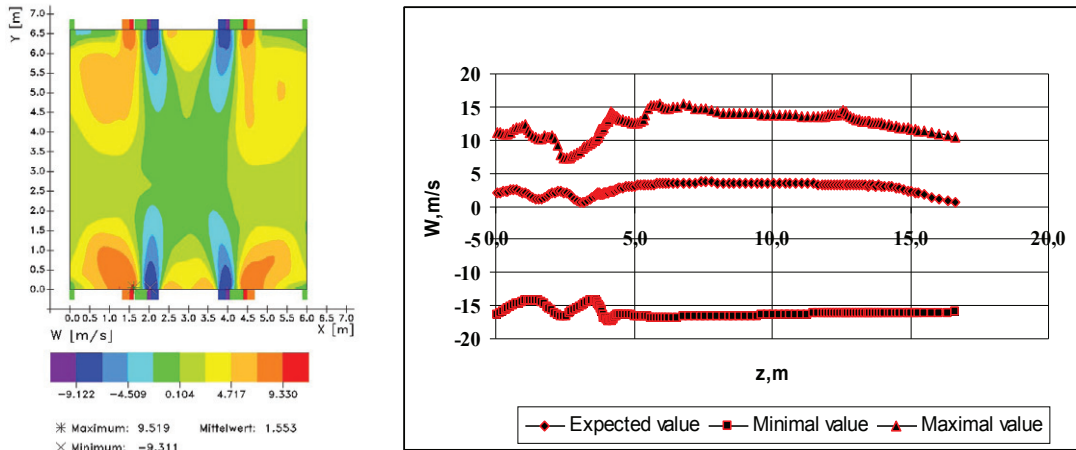

Fig. 5. The distribution of the velocity component  $W$  in the burner section and the height of the combustion chamber

Deep interpenetration of colliding jets and the presence of transverse velocity gradients turbulence flow. Significant turbulence flow occurs in good fuel filling space, and therefore increased residence time of the combustible mixture in the furnace space. Due to the fact that combustion chamber above the burner is not completely filled, the front and back walls appear the vortices. Part of the upward flow is directed to the output of the furnace. Excess flow is recycled to form the walls of the vortex above the burner area. The presence of rotational flow in the wall zone promotes uniform heating of the surfaces and reduces the slagging of screens to reduce corrosion and overheating of the heat [6]. As the distance from the plane of the burner velocity field is leveled, the upward flow expands and weakens the vortex flow pattern. To exit the combustion chamber upward flow expands rapidly and the output is uniformly distributed over the entire cross section.

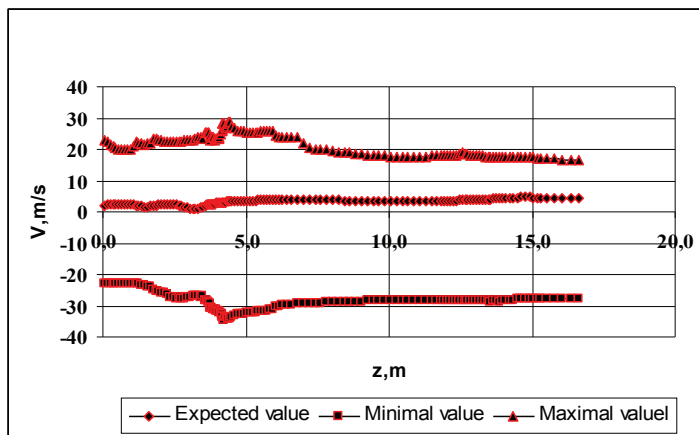

Fig. 6. The distribution of the vector full speed adjustment of the combustion chamber

The combustion of pulverized coal in the combustion chamber takes place in dusty non-isothermal gas jet propagating in a medium hot flue gases. Dusty jet (fuel mixture flow) in the flue space is distributed along with the surrounding flow of secondary air [7]. The temperature conditions, in which the combustion of coal dust occurs in the combustion chamber, are in turbulent jets and determined the



intensity of heat and mass transfer in them and the nature of their distribution in the flue gases. Therefore, the laws of distribution of temperature and velocity fields [8] determine the physical conditions of combustion in turbulent jets.

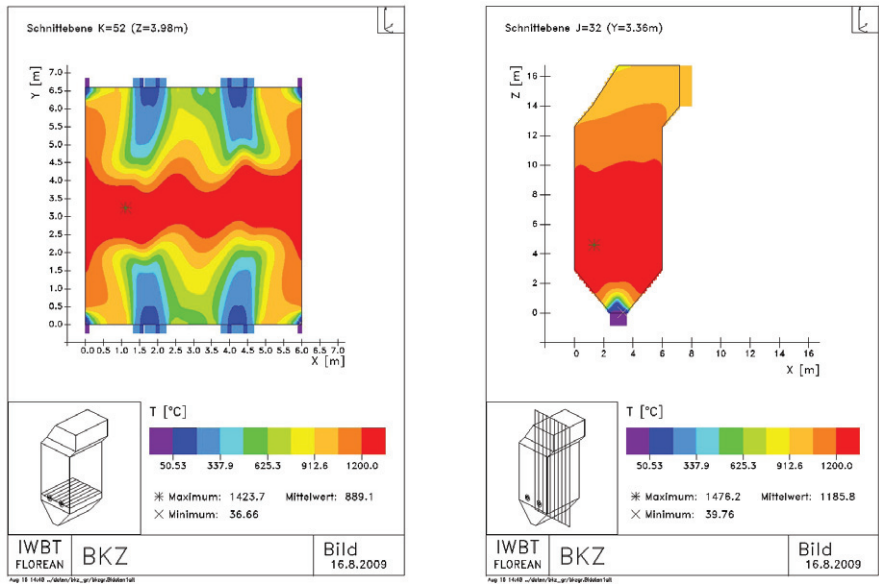

Fig. 7. The temperature profile of the burners and in the longitudinal section of the combustion chamber

Thus, maximum convective transfer in physical model is observed in the area of dust coal supply. Therefore, the most intensive burning you will see in the centre of furnace, where maximums as on Figure 8, 9 in distribution of temperature in different segments of combustion chamber.

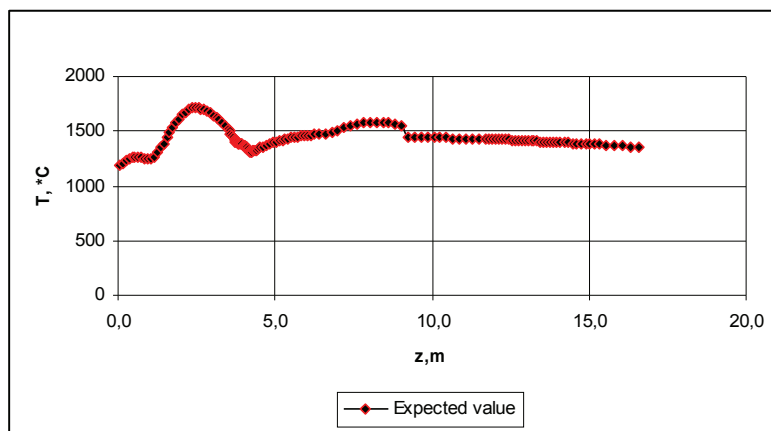

Fig. 8. The temperature distribution on the height of the combustion chamber

#### 4. Conclusion

Aerodynamic conditions created in the furnace space for coal-fired traffic flows lead to the fact that in the plane of the feed and fuel mixture in the plane of symmetry of the combustion chamber there is a maximum convective transport. Combustion reactions are most intensive here with associated significant change in temperature in this area. As we move towards the exit of combustion chamber temperature falls uniformly.

#### Reference

- [1] Polezhayev VI, Bune AV, Verezub NA. Mathematic modeling of convective heat mass exchange on the basis equivalence Navew-Stox. *Science*, Moscow; 1987, p. 256.
- [2] Oran E, Boriss J. Numerical modeling of reacting flows. *World*, Moscow; 1990, p. 660.
- [3] Pauker W. Creating data sets for FLOREAN using the tool PREPROZ. *IWBT*, Braunschweig; 1997, p. 3-24.
- [4] Müller H. Numerische Berechnung Dreidi-mensionaler Turbulenter Stromungen in Dampf-ferzeugern mit Wärmeübergang und Chemischen Reaktionen am Beispiel des SNCR- Verfahrens und der Kohleverbrennung. *Fortschr.-Ber.* VDI-Verlag; 1992, p. 158.
- [5] Askarova AS., Messerle VE, Ustimenko AB, Nagibin AO. Dust coal burning in the furnace with plasma heating system. *Termophys Aromech* 2010;**30**:467-476.
- [6] Askarova AS, Messerle VE, Ustimenko AB, Nagibin AO, Lavrishev OA. Modeling of plasma supported coal combustion in full scale boiler. *Thermotech* 2010;**12**:149-162.
- [7] Askarova A, Karpenko E, Lavrishcheva E, Messerle V, Ustimenko A. Plasma-supported coal combustion in boiler furnace. *IEEE Transact Plasma Sci*; 2007;**13**:1607-1616.
- [8] Askarova AS, Messerle VE, Nagibin AO, Ustimenko A.B. Modeling of plasma assisted coal dust ignition and combustion. *Acta Tech* 2011;**48**:338-355.